



*The Right Connection®*

## Petrochemical Life Cycle



### ① ② ③ Exploration and Production

[dixonvalve.com](http://dixonvalve.com) • *Customer Service:* 877.963.4966



# Petrochemical Life Cycle ① Exploration and Production

The content in this phase of the Petrochemical Life Cycle (see pages 22-23) is focused on the numerous transfer applications in the oil and gas field. Featured are the Dixon products used within the Exploration / Production and Transportation segment.

Please refer to the Dixon Price List or [dixonvalve.com](http://dixonvalve.com) for specific part numbers and various other products used in the transfer and control of liquids, gases and dry materials.

---

## Table of Contents

Boss Low Pressure System Products Introduction.....	3
Combination Nipples - Short and Standard.....	4
Frac Fittings .....	5
One-Piece and Two-Piece Hammer Union Nuts .....	6
Flange Adapters .....	7
Hammer Unions and Hammer Union Caps & Plugs.....	8
Cam & Groove, Abrasion Resistant Inserts, King Safety Cables .....	9
Vent-Lock Cam & Groove.....	10
EZ Boss-Lock and King Crimp Couplers.....	10
Holedall External Swage .....	11
Bauer Style Quick Connect .....	11
GSM Armored Hose .....	11
Rail Car Unloading .....	12-13
Dry Disconnects .....	13
Low Pressure Swivels .....	14
Safety Breakaways.....	14
Valves .....	15-16
Hydraulic Quick-Disconnects.....	17-20
Hydraulic Adapters .....	21
Air & Water Utilities.....	21
Petro-Chemical Lifecycle.....	22-23

---

## Safety

Dixon's couplings and retention devices are designed to work safely for their intended use. The selection of the proper hose, coupling and retention device, and the proper application of the coupling to the hose are of utmost importance.

Users must consider the size, temperature, application, media, pressure and hose and coupling manufacturer's recommendations when selecting the proper hose assembly components. Dixon recommends that all hose assemblies be tested in accordance with the Association for Rubber Products Manufacturers (ARPM) recommendations and be inspected regularly (before each use) to ensure that they are not damaged or have become loose. Visit [ARPMINC.com](http://ARPMINC.com) for more information.

Where safety devices are integral to the coupling, they must be working and utilized. The use of supplementary safety devices such as safety clips or safety cables are recommended.

If any problem is detected, couplings must be removed from service immediately.

Dixon is available to consult, train and recommend the proper selection and application of all fittings we sell. We strongly recommend that distributors and end users make use of Dixon's Testing and Recommendation Services. Call 877.963.4966 or click [dixonvalve.com](http://dixonvalve.com) to learn more.



# BOSS LPS Products

## Low Pressure Systems

Dixon is committed to understanding customer challenges and developing solutions. Key to achieving these objectives is Dixon's Innovation Center, an engineering, research and training facility integral in the development of the Boss LPS products defined in this brochure.



## Hydraulic Fracturing Site

Boss LPS (Low Pressure System) products are used in many of the applications found at hydraulic fracturing sites from the water source up to high pressure pumps. Please refer to the following pages for detailed information on Dixon's newest and rapidly expanding product line.

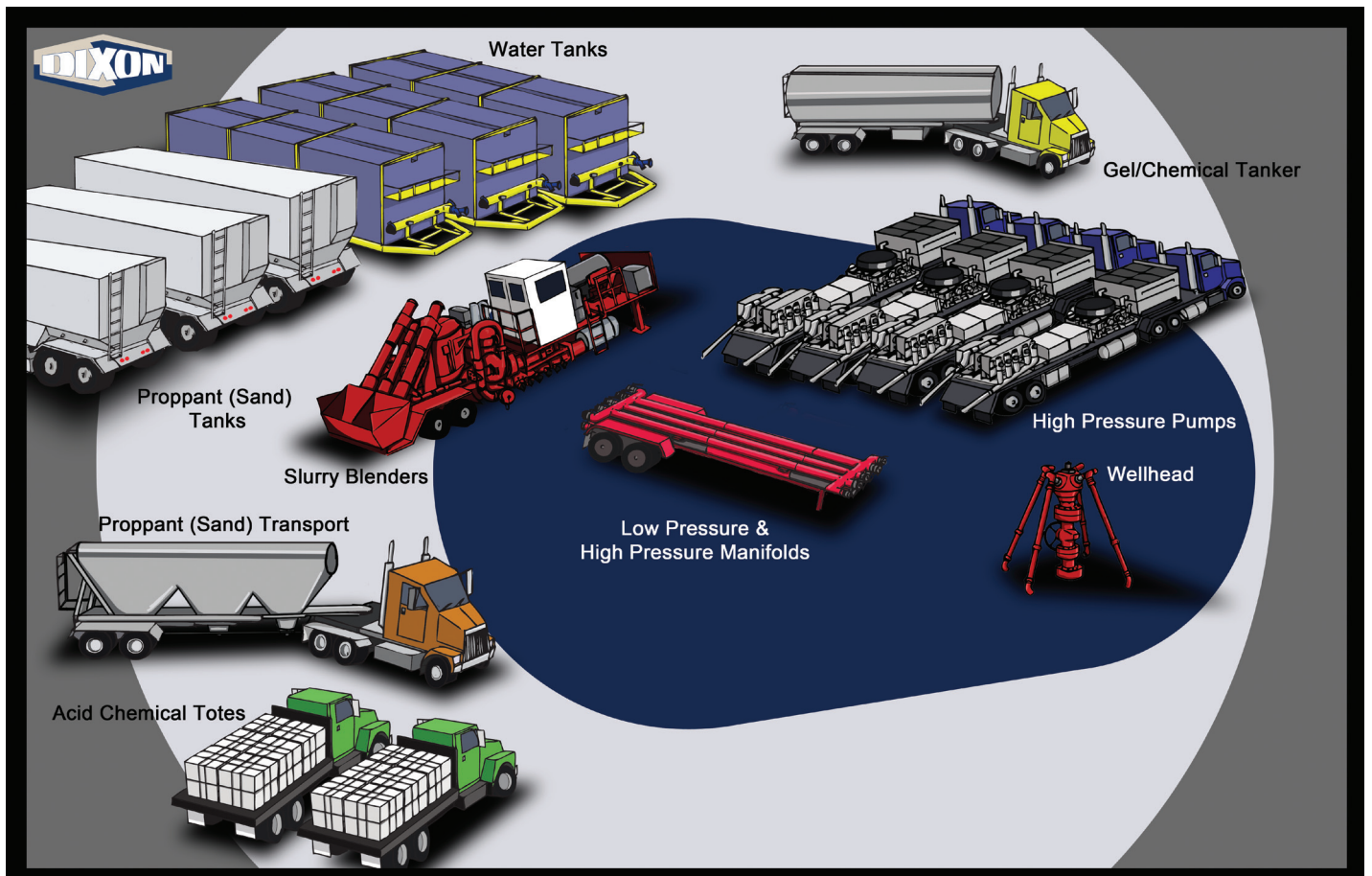

## King Crimp Style Short Combination Nipples, Ferrules and Sleeves



**Application:**

- recommended for low-pressure discharge and suction service for compatible liquids

**Material:**

- schedule 40 plated carbon steel to ASTM standards

**Size:**

- 8"



Size	Grooved (plated) Part #	NPT (plated) Part #	Description
8"	<b>STV80CS</b>	<b>STC80CS</b>	short combination nipple
	<b>CFS800-1CS</b> through <b>CFS800-8CS</b>		ferrules (carbon steel, .120 wall thickness), other sizes made to order, call Dixon for more information
	<b>S900X400X120CS,</b> <b>S925X400X120CS</b>		sleeves (carbon steel, .120 wall thickness), other sizes made to order, call Dixon for more information

## Grooved and NPT Threaded End King Combination Nipples



grooved end



NPT threaded end

**Application:**

- recommended for low-pressure transfer and suction service for compatible liquids

**Feature:**

- crimp sleeves are available and recommended for reliable assemblies
- **contact Dixon for compatible sleeve recommendations for these nipples**

**Materials:**

- unplated steel and plated steel

**Sizes:**

- ½" through 12"

Size	Grooved (unplated) Part #	NPT (plated) Part #	Description
8"	<b>STV80</b>	<b>STC80</b>	standard combination nipple
10"	<b>STV100</b>	<b>STC100</b>	standard combination nipple
12"	<b>STV120</b>	<b>STC120</b>	standard combination nipple

## Special Sleeve and Ferrule Part Numbering System

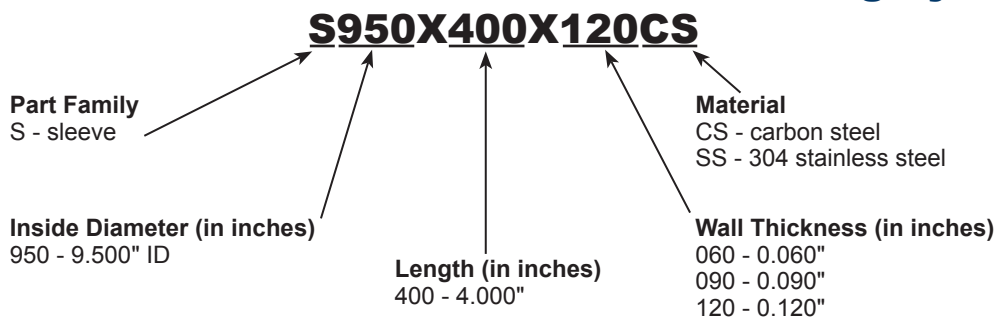



# One-Piece Dixon Frac Fittings

**Application:**

- used in the transfer of water, chemicals and sand slurry at hydraulic fracturing sites

**Features:**

- one-piece stem design eliminates leak path experienced with two-piece threaded systems
- interchangeable with current fittings; phase them into your operation
- 400 PSI (28 BAR) working pressure at 70°F (21°C) for 3" and 4" sizes; 4:1 safety factor (SF) <sup>1</sup>
- 150 PSI (10 BAR) working pressure at 70°F (21°C) for 6" size; 4:1 safety factor (SF)
- 150 PSI (10 BAR) working pressure at 70°F (21°C) for 8" size; 3:1 safety factor (SF)



**Materials:**

- frac fittings: machined iron to ASTM standards; all stems zinc plated
- male 3", 4" and 6" NPT fittings are schedule 80 pipe; 8" NPT fittings are schedule 40 pipe; all sizes meet ASTM standards

**Sizes:**

- 3", 4", 6" and 8"

<sup>1</sup> 400 PSI (28 BAR) working pressure with a minimum 4:1 safety factor (*hose burst: hose working pressure*) is only achieved with:

- 3" size uses standard crimp ferrules
- 4" size requires heavy duty (HD) crimp ferrules, CF400-6CSDH through CF400-16CSDH

Note: Water and petroleum transfer hoses rated from 100 to 300 PSI (7 to 21 BAR) WP (4:1 SF) have excellent test results with the standard King Crimp ferrules *CF400-xxCS*.



Figures 100 and 206 available



Figures 100 and 206 available



Figure 100		
Size	Part #	Description
3"	<b>HUF100300CS</b>	female fitting
	<b>HUM100300CS</b>	male fitting (includes nut)
	<b>STC35CS</b>	male NPT fitting
	<b>HU100300N</b>	wing nut
4"	<b>HUF100400CS</b>	female fitting
	<b>HUM100400CS</b>	male fitting (includes nut)
	<b>STC40CSDH</b>	male NPT fitting
	<b>HU100400N</b>	wing nut
6"	<b>HUFALL600CS</b>	female frac fitting
	<b>HUM100600CS</b>	male frac fitting (includes nut)
	<b>STC60CS</b>	male NPT fitting
	<b>HU100600N</b>	wing nut (forged)
8"	<b>HUFALL800CS</b>	female frac fitting
	<b>HUM100800CS</b>	male frac fitting (includes nut)
	<b>HU100800N</b>	wing nut (forged)

Figure 206		
Size	Part #	Description
3"	<b>HUF206300CS</b>	female fitting
	<b>HUM206300CS</b>	male fitting (includes nut, O-ring)
	<b>STC35CS</b>	male NPT fitting
	<b>HU206300N</b>	wing nut
4"	<b>HUF206400CS</b>	female fitting
	<b>HUM206400CS</b>	male fitting (includes nut, O-ring)
	<b>STC40CSDH</b>	male NPT fitting
	<b>HU206400N</b>	wing nut
6"	<b>HUFALL600CS</b>	female frac fitting
	<b>HUM206600CS</b>	male frac fitting (includes nut, O-ring)
	<b>STC60CS</b>	male NPT fitting
	<b>HU206600N</b>	wing nut (forged)
8"	<b>HUFALL800CS</b>	female frac fitting
	<b>HUM206800CS</b>	male frac fitting (includes nut, O-ring)
	<b>HU206800N</b>	wing nut (forged)

- 2" will be available soon

## One-Piece Hammer Union Nuts

### Application:

- used with any hammer union fittings requiring reliable nuts

### Features:

- long lasting and dependable nut
- all nuts are interchangeable with reliable brands
- 2,000 PSI (138 BAR) cold working pressure
- 6" and 8" sizes have a 4 lug design for more surface area to hammer

### Material:

- forged steel meeting AISI standards

### Sizes:

- 3", 4", 6" and 8"



3" and 4"



6" and 8"

Size	Part #	Description
3"	<b>HU100300N</b>	wing nut, figure 100
	<b>HU206300N</b>	wing nut, figure 206
4"	<b>HU100400N</b>	wing nut, figure 100
	<b>HU206400N</b>	wing nut, figure 206
6"	<b>HU100600N</b>	wing nut, forged, figure 100
	<b>HU206600N</b>	wing nut, forged, figure 206
8"	<b>HU100800N</b>	wing nut, forged, figure 100
	<b>HU206800N</b>	wing nut, forged, figure 206

## Two-Piece Hammer Union Nuts

### Applications:

- replacement for damaged hammer union nuts
- used with male one-piece flange adapters

### Features:

- lug design provides enlarged surface area to hammer
- repair nut is pinned and bolted for perfect alignment
- nut can be installed on pre-existing hammer union assembly
- 2,000 PSI (138 BAR) cold working pressure
- 4" Figure 200/206 nut is interchangeable with reliable brands
- 6" and 8" Figure 100/200/206 nuts are interchangeable with reliable brands

### Material:

- forged steel meeting AISI standards

### Sizes:

- 4", 6" and 8" (bolts included)



Dixon recommends using Loctite® Threadlocker Red 271™ when bolting together two-piece hammer union nuts to ensure that bolts do not loosen when in service. Option two is to weld the seams of the split nut. Bolt torque recommendation is 60 foot pounds.



Size	Part #	Description
4"	<b>HU200400RN</b>	split nut, figure 200/206, blue (bolts included)
6"	<b>HU100600RN</b>	split nut, figure 100, black (bolts included)
	<b>HU200600RN</b>	split nut, figure 200/206, blue (bolts included)
8"	<b>HU100800RN</b>	split nut, figure 100, black (bolts included)
	<b>HU200800RN</b>	split nut, figure 200/206, blue (bolts included)

## One-Piece Flange Adapters

**Application:**

- used in the transfer of water, brine, water-based chemicals, water-based acids, and gelatinous proppant (sand) slurry at hydraulic fracturing sites

**Features:**

- flange x female or male hammer union straights (standard or short length)
- 45° elbows in female and male (flange x hammer union)
- no welds or pipe threads to deteriorate causing premature leakage
- two-piece nut is pinned and bolted for perfect alignment
- all 4" Figure 206 threads are interchangeable with other reliable brands
- all 4" 150# flanges are compatible with other reliable brands

**Material:**

- iron adapters meet ASTM standards
- forged steel nuts meet AISI standards

**Size:**

- 4"

Size	Part #	Description	Overall Length
4"	<b>HUF206400FLG</b>	flange x female hammer union	5-1/8"
	<b>HUF206400FLG-ST</b>	flange x female hammer union, short	3"
	<b>HUM206400FLG</b>	flange x male hammer union (includes nut, bolts and Buna-N O-ring)	5-5/32" (with nut)
	<b>HUM206400FLG-ST</b>	flange x male hammer union, short (includes nut, bolts and Buna-N O-ring)	3-13/32" (with nut)
	<b>HUF206400FLG-45</b>	flange x female 45° elbow	10-31/32"
	<b>HUM206400FLG-45</b>	flange x male 45° elbow (includes nut, bolts and Buna-N O-ring)	12-1/32" (with nut)



## One-Piece 150# Flange to Weld Adapters

**Application:**

- used on a 12" pipe manifold to transfer water, brine, water-based chemicals, water-based acids or gelatinous proppant (sand) slurry at hydraulic fracturing sites

**Features:**

- no welds or pipe threads to deteriorate causing premature leakage
- easy to weld to 12" pipe manifolds
- formed butt weld provides accurate alignment
- the 4" 150# flange is compatible with other reliable brands

**Material:**

- WCA (weldable cast steel, grade A) meeting ASTM standards

**Sizes:**

- 7½" and 10½" lengths standard

Size	Part #	Description
7½"	<b>WA4FL12X750-1</b>	150# flange x weld adapter, 1 hole
7½"	<b>WA4FL12X750-2</b>	150# flange x weld adapter, 2 holes
10½"	<b>WA4FL12X1050-1</b>	150# flange x weld adapter, 1 hole
10½"	<b>WA4FL12X1050-2</b>	150# flange x weld adapter, 2 holes

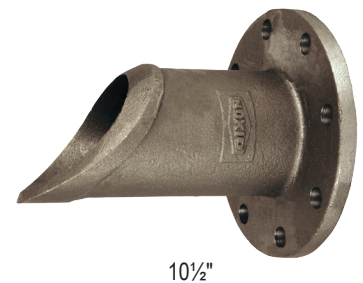

1-Hole Pattern



2-Hole Pattern

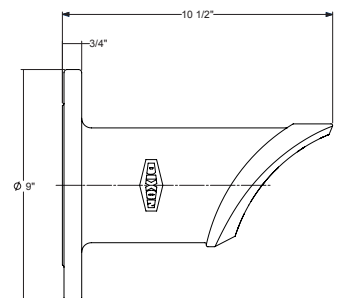
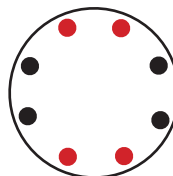



# Hammer Unions



100 series



200/206 series

**Application:**

- used in the transfer of water, chemicals and sand slurry at hydraulic fracturing sites

**Features:**

100 series:

- used on low pressure manifolds and lines in applications running air, water, oil or gas up to 1,000 PSI (69 BAR) NSCWP (non-shock cold working pressure)
- threaded and butt-weld ends available

200/206 series:

- used in general service applications running air, water, oil or gas up to 2,000 PSI (138 BAR) NSCWP (non-shock cold working pressure)
- O-ring mounted fitting body

**Materials:**

- 100 series: steel; 200/206 series: forged steel

**Sizes:**

- 100 series: 2", 2½", 3", 4", 6" and 8"
- 200/206 series: 1", 1½", 2", 2½", 3", 4", 6" and 8"

# Hammer Union Caps and Plugs

**Application:**

- prevents leakage of hydraulic fracturing fluids from hammer union connections used on manifolds and hose assemblies; the fracking equipment can be in pressurized service or in transit to an alternate location



cap

**Features:**

- caps and plugs are produced of forged steel to ensure longevity, reliability and performance
- cap is designed with larger lugs for easier installation and disassembling
- cap design includes a threaded bolt hole for attaching chain or cable
- plug is designed with larger handle for easier installation and disassembling
- plug design includes a handle hole to attach chain or cable
- chain is zinc plated for longer life

**Material:**

- forged steel meeting AISI standards
- chain is welded Grade 30 steel
- bolt is Class 2A
- other materials available contact Dixon

**Size:**

- 4"



plug

Size	Part #	Description
4"	<b>HUC207400</b>	blanking cap, Figure 207
	<b>HUP207400</b>	blanking plug, Figure 207
	<b>HUCH20CS</b>	chain is 5/16" links by 20" overall length
	<b>HUBT716X75</b>	bolt is 7/16"-14 threads by 3/4" long
	<b>HUC207400BC</b>	blanking cap with bolt/chain
	<b>HUP207400C</b>	blanking plug with chain

# Cam & Groove

**Application:**

- used as fittings for sand and ceramic proppants (material that keeps an induced hydraulic fracture open following a fracturing treatment)

**Feature:**

- adapters also available, contact Dixon for information or visit [dixonvalve.com](http://dixonvalve.com)

**Materials:**

- unplated, plated malleable iron or ductile iron

**Sizes:**

- 1½", 2", 3", 4" and 6"

Size	Dixon / Boss-Lock Type E Part #	Dixon Type C Part #	Boss-Lock Type C Part #
1½"	<b>150-E-MI</b>	<b>150-C-MI</b>	<b>IC150</b>
2"	<b>200-E-MI</b>	<b>200-C-MI</b>	<b>IC200</b>
3"	<b>300-E-MI</b> <sup>1,2</sup>	<b>300-C-MI</b> <sup>1</sup>	<b>IC300</b>
4"	<b>400-E-MI</b> <sup>1,2</sup>	<b>400-C-MI</b> <sup>1</sup>	<b>IC400</b> <sup>1</sup>
6"	<b>600-E-MI</b> <sup>1,2</sup>	<b>600-C-MI</b> <sup>1</sup>	<b>IC600</b> <sup>1</sup>

<sup>1</sup> ductile iron

<sup>2</sup> King Crimp style



Dixon Type C



Dixon / Boss-Lock Type E

## Abrasion Resistant Inserts

**Application:**

- for extending the life of adapters when transferring proppant to storage tanks

**Features:**

- abrasion resistance extends life of adapters
- available with multiple adapter materials

**Materials:**

- insert: UHMW polyethylene
- adapters: aluminum, brass, iron, stainless steel

**Size:**

- 4"

Part #	Description
<b>400-A-ALINSERT</b>	aluminum adapter with insert
<b>400-A-BRINSERT</b>	brass adapter with insert
<b>400-A-MIINSERT</b>	iron adapter with insert
<b>400-A-SSINSERT</b>	stainless steel adapter with insert

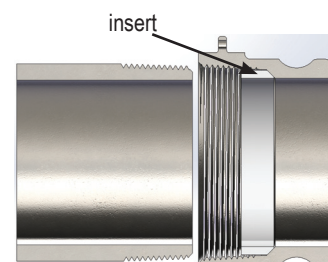

## King Safety Cables

**Application:**

- When hose, couplings or clamps fail, or there is an accidental separation of the assembly, King safety cables minimize injuries to operators and damage to equipment by providing a standby safety for hose.

**Features:**

- WSR for hose-to-tool service and W for hose-to-hose service; other cable options are available, contact Dixon for additional information or visit [dixonvalve.com](http://dixonvalve.com)

**Materials:**

- steel or stainless steel



Style WSR for hose-to-tool service



Style W for hose-to-hose service

# Vent-Lock (safety cam and groove)



Vent-Lock Type C



Vent-Lock Type A

**Application:**

- transfer of liquids and solids, with a safer disconnection

**Features:**

- safety release cam and groove couplings that permit the release of static pressure when disconnecting hose assembly
- venting system protects operator from being sprayed with hazardous or non-hazardous fluids

**Materials:**

- 316 stainless steel
- other materials to be available, contact Dixon

**Sizes:**

- 1", 2"

Size	Vent-Lock Type A Part #	Vent-Lock Type C Part #	Vent-Lock Type E Part #	Vent-Lock Type DC Part #	Vent-Lock Type DP Part #
1"	<b>L100-A-SS</b>	<b>L100-C-SS</b>	<b>L100-E-SS</b>	<b>L100-DC-SS</b>	<b>L100-DP-SS</b>
2"	<b>L200-A-SS</b>	<b>L200-C-SS</b>	<b>L200-E-SS</b>	<b>L200-DC-SS</b>	<b>L200-DP-SS</b>

# EZ Boss-Lock and King Crimp Couplers

## EZ Boss-Lock and King Crimp Couplers

**Applications:**

- suitable for water, chemical, acid, and crude transfer as well as other petrochemical applications; creates a reliable assembly when used with King crimp sleeves and ferrules

**Features:**

- positive lock handles - prevent accidental uncoupling (EZ Boss-Lock female couplers)
- handles lock automatically when closed (EZ Boss-Lock)
- handles available in forged brass or investment cast stainless steel to meet chemical requirements
- sleeve and ferrule wall thickness varies from .062" to .120"
- working pressures are available, call Dixon or visit [dixonvalve.com](http://dixonvalve.com) for information

**Materials:**

- EZ Boss-Lock: 316 stainless steel
- King Crimp couplers and adapters: aluminum, brass, 316 stainless steel or unplated iron
- sleeves and ferrules: stainless or carbon steel

**Sizes:**

- EZ Boss-Lock and King Crimp couplers and adapters: 1"- 6"
- King Crimp sleeves: 1"- 12"
- King Crimp ferrules: 1"- 8"



Not recommended for compressed gas, air or steam

Under no circumstances should the EZ Boss-Lock cam arms be used on any fitting not specifically designed for their use.



Pressure rating on King Crimp adapters is based on the seal of the mating part.

**Only use the crimp style shanks with the crimp style sleeves and ferrules.** Due to differences in dimensions and tolerances for safety reasons, do not interchange other manufacturer's products with Dixon products.



# Holedall External Swage Fittings

## Applications:

- used in suction and return lines for drilling mud, oil suction and discharge, loading and unloading

## Features:

- system requires no bolts and provides a coupling with no protrusions
- hose of various lengths and styles can be coupled
- available with pipe thread, plain, grooved or flanged ends
- 300-600 PSI working pressure depending on size, call Dixon for more information
- Dixon Holedall stems and ferrules are specifically designed to be used together as a coupling system. Due to differences in dimensions and tolerances, for safety reasons, do not use other manufacturer's stems or ferrules with Dixon Holedall products. 

## Materials:

- stainless steel or carbon steel

## Sizes:

- 1½" - 10" hose ID

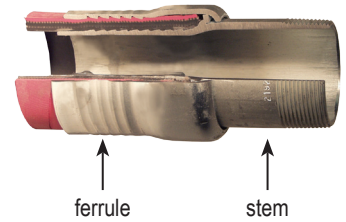

# Bauer Style Quick Connect Fittings

## Applications:

- used in the transfer of water and other liquids used in various oilfield applications

## Features:

- hot dipped galvanized fittings with a double pin locking lever provide smooth closing action
- safety pin, standard with coupler, prevents accidental openings
- configurations include 45° and 90° elbows, ASA flange, hose shank, NPT, butt-weld, plugs, gaskets and extra long
- not recommended for use with chemicals or any hazardous type materials 
- additional configurations available, call Dixon for information

## Material:

- galvanized steel

## Sizes:

- 2" - 12"



male x hose shank



female x hose shank

# GSM Armored Hose

## Applications:

- fluid transfer on drilling platforms, blenders and equipment, mobile off-highway equipment for supporting oil and gas services in the field

## Features:

- extremely flexible armor protects from heat and harsh environments in applications for steam, water, gases, hydraulic fluids, grease and abrasives
- heat resistant insulation to 1000°F
- temperature rating depends on specific applications, consult Dixon
- a variety of end connections are available

## Materials:

- armor: galvanized steel or stainless steel
- wide selection of inner hoses specific to the demands of the application are industrial, hydraulic, stainless steel or PTFE

## Sizes:

- ¼" through 12" bore with lengths to 120'

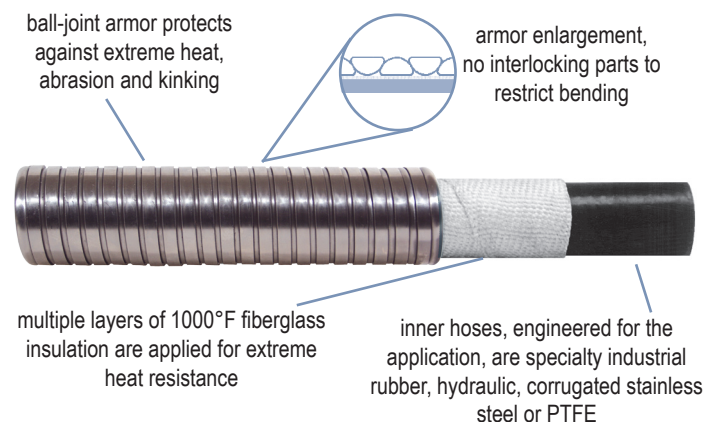

# Rail Car Unloading

## Rail Car Unloading Assemblies

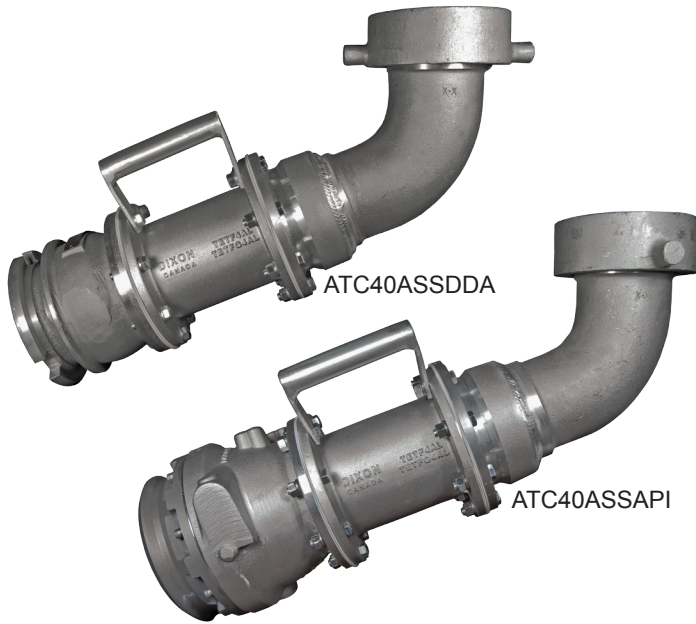

**Application:**

- used to connect to rail cars for the loading and unloading of crude oil and other media used in the petrochemical field

**Features:**

- rugged body construction
- easy carry handle
- safe and reliable - valves will not open unless fittings are properly connected
- API configuration uses a stainless steel spring on the adapter and coupler for corrosion resistance
- drain and sample ports and many other configurations are available, call Dixon for information

**Material:**

- body: aluminum

**Size:**

- 4"

## Components for Custom Assemblies

- additional components are available, please send an email to [sales@dixonvalve.com](mailto:sales@dixonvalve.com) or call 800.355.1992 for more information



4" transfer hose fittings



4" dry disconnect and API fittings



4" sight glass



4" flange extension



ball valve



mates to a tank car with 5" male tank car thread



mates to a tank car with 4" cam and groove connections

# Rail Car Unloading Dry Disconnects

## Products Used with Rail Car Adapters

### Application:

- ensures a quick and spill-free connection in the bulk transfer of petroleum and chemicals

### Features:

- coupler has built-in swivel
- shaft journal in stainless steel embedded in PTFE eliminates seizure
- riveted piston pin to minimize the risk for failure under extreme pressure conditions
- the protective ring is a specially formulated, weather resistant and electrically conductive rubber compound

### Materials:

- aluminum
- rollers: aluminum-bronze on stainless steel shaft
- stainless steel ball bearings

### Size:

- 4"



## API Coupler

### Features:

- coupler includes a snap-on connection

### Materials:

- aluminum
- nose seal - bonded FKM-B

### Size:

- 4"



# Cam and Groove Style Dry Disconnects

### Features:

- compatible with most cam and groove style dry disconnects
- spring loaded sealing device "snaps" closed should the valve become disconnected with the poppet open
- two-piece adapter design allows easy rebuilding of adapters
- EZ Boss-Lock cam arms provide security against accidental opening
- automatic closing poppet assembly
- stainless steel handle allows product exposure to corrosive chemicals or wash down service
- fully interchangeable with Kamvalok® style fittings

### Sizes:

- 1½", 2" and 3" female NPT x 2", 2½" and 4" coupler and adapter

### Materials:

- stainless steel or aluminum
- call Dixon for information on chemical compatibility, size, material selection and special configurations

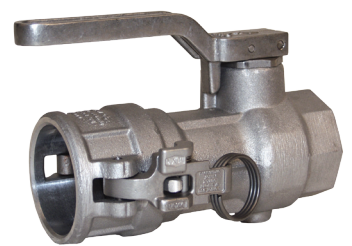

straight coupler



DBA adapter



# Low Pressure Swivels

**Applications:**

- V-ring: loading arm, floating roof drain, floating suction
- O-ring: loading arm, hose loaders

**Features:**

- full 360° rotational movement offers maximum flexibility
- wide spacing between dual ball bearing raceways ensures greater load-bearing capacity
- precision-machined design ensures alignment and years of trouble-free service
- an O-ring dust seal protects the ball races and seal chamber from outside elements.
- radius elbow design ensures a smooth flow pattern

**Materials:**

- V-ring: carbon steel, stainless steel or aluminum
- O-ring: carbon steel, stainless steel, aluminum brass or iron

**Sizes:**

- V-ring: 2" through 8"
- O-ring: 1" through 4"



## Typical Applications

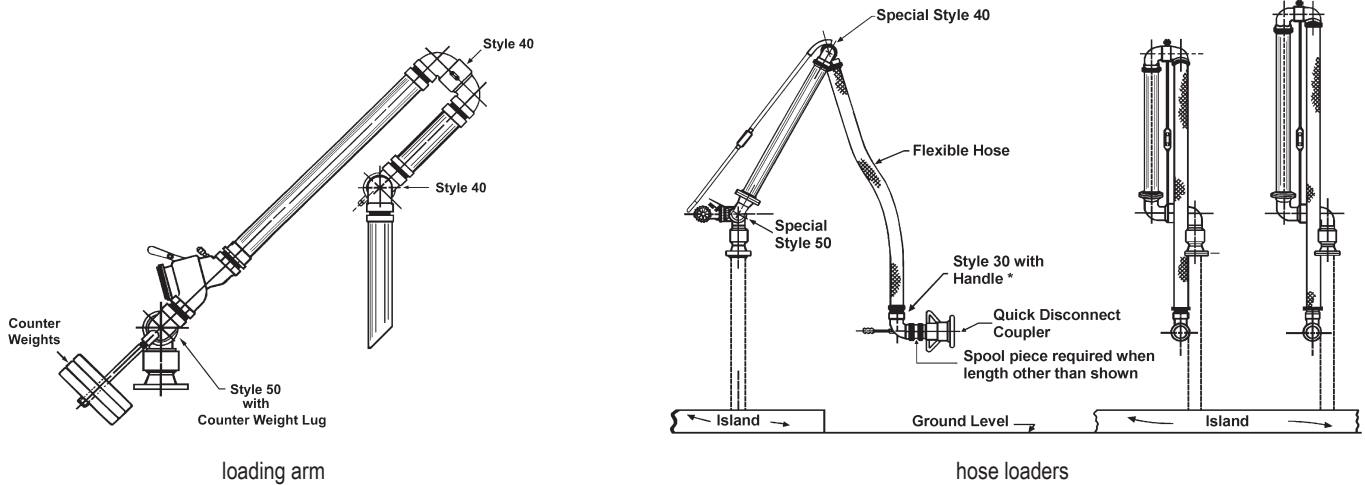

# Safety Breakaway Couplings

**Application:**

- used most commonly on tank trucks, railcars and barges to limit the possibility of environmental impact and loss of product resulting from a break in a connection

**Features:**

- marine version - hose to hose
- industrial version - fixed point to hose
- coupling automatically senses an excessive load, closes the valves and disconnects
- high flow rate / low pressure drop
- female NPT is standard, optional ANSI / DIN flanges or male NPT are available
- working pressure: stainless steel **360 PSI** and aluminum (industrial version) **230 PSI** at ambient temperature (70°F)

**Materials:**

- industrial version: 316 stainless steel or aluminum
- marine version: 316 stainless steel
- Viton® is standard seal

**Sizes:**

- 2", 3", 4", 5", 6" and 8"



marine version



industrial version

# Valves

## Brass Ball Valves

### Applications:

- controls the flow of crude oil and natural gas in various applications

### Features:

- rated to 600 PSI WOG: 150 PSI saturated steam
- blow-out proof stems
- meets WW-V 35C, Type II Composition
- full and standard ports available, both repairable
- ball valve handle replacements available, call Dixon for information

### Materials:

- body, balls and stems: brass
- handles and nuts: plated steel with vinyl sleeves
- glass-filled reinforced PTFE seats and stuffing box ring; stem seals and washers

### Sizes:

- $\frac{1}{4}$ ",  $\frac{3}{8}$ " and  $\frac{1}{2}$ " in full port design
- $\frac{3}{4}$ ", 1", 1 $\frac{1}{4}$ ", 1 $\frac{1}{2}$ ", 2", 2 $\frac{1}{2}$ " and 3" in standard port design



## Locking Handle Brass Ball Valves

### Applications:

- controls the flow of crude oil and natural gas in various applications, from injection systems to blow-out prevention in wells

### Features:

- rated to 600 PSI WOG: 150 PSI saturated steam
- blow-out proof stem
- stainless steel sliding lock mechanism secures handle in open or closed position; can be pad-locked open or closed
- full and standard ports available, both repairable

### Materials:

- body and stems: brass
- ball: chrome-plated brass
- stem: RPTFE

### Sizes:

- $\frac{1}{4}$ ",  $\frac{3}{8}$ " and  $\frac{1}{2}$ " in full port design
- $\frac{3}{4}$ ", 1", 1 $\frac{1}{4}$ ", 1 $\frac{1}{2}$ " and 2" in standard port design

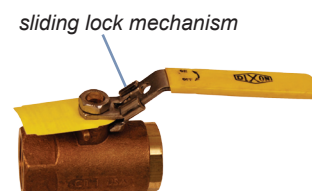

## 3-Way Diverting Ball Valves

### Applications:

- controls or divert the flow of media in various applications, from injection systems to blow-out prevention in wells

### Features:

- rated to 400 PSI WOG: 100 PSI saturated steam
- blow-out proof stem
- PTFE seats, seals, and thrust washer
- adjustable stem packing
- temperature range to 344°F
- standard port design

### Materials:

- body: brass
- ball: chrome-plated brass

### Sizes:

- $\frac{1}{2}$ ",  $\frac{3}{4}$ ", 1", 1 $\frac{1}{4}$ ", 1 $\frac{1}{2}$ " and 2"



## Locking Handle Stainless Steel Ball Valves

sliding lock mechanism



full port

### Application:

- controls the flow of caustic and corrosive fluid in various oil field applications

### Features:

- full port rated to 1000 PSI WOG: 100 PSI saturated steam
- reduced port rated to 800 PSI WOG: 100 PSI saturated steam
- blow-out proof stem design
- temperature range -20°F to 450°F
- full and standard ports available
- lockable

### Materials:

- body, ball and stem: 316 stainless steel
- seat, joint gasket and thrust washer: PTFE

### Sizes:

- 1/4", 3/8", 1/2", 3/4", 1", 1 1/4", 1 1/2" and 2" in reduced port and full port design

sliding lock mechanism

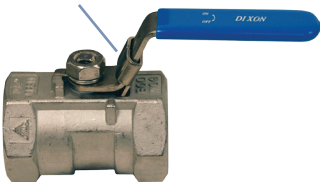

reduced port

## Ductile Iron Butterfly Valves



*NOT RECOMMENDED FOR STEAM SERVICE*

### Application:

- controls flow of water, chemicals and sand slurry

### Features:

- rated to 200 PSI
- will lock "open" or "closed"
- for use between two 150# flanges
- number of holes on the valve depends on the body size

### Materials:

- body: ductile iron, ASTM A536
- disc: nickel plated ductile iron
- top and bottom stems: 416 stainless steel
- seal and stem seals: Buna-N
- bushing: PTFE

### Sizes:

- 3", 4", 6" and 8"



## Gate Valves

### Applications:

- used for steam service in pipe lines or in other high temperature or pressure applications

### Features:

- bolted bonnet
- female threaded ends
- ASTM A105, ANSI B120.1: class 800
- rated to 1975 PSI
- maximum temperature: 800°F

### Material:

- body: forged steel

### Sizes:

- 1/2", 3/4", 1", 1 1/4", 1 1/2" and 2"





# Hydraulic Quick Disconnects

## VEP & VEP-BOP Series Thread To Connect Flush Face

### Application:

- used in a variety of drilling rig applications and hydraulic power units where the ability to connect and disconnect under pressure is necessary

### Features:

- threaded, no spill design provides the ideal solution for high pressure, high impulse applications
- connect and disconnect under pressure
- patented valve retention system minimizes pressure drop and maximizes connection and pressure performance
- trivalent chrome plating provides superior corrosion resistance
- Blow-out prevention (BOP) version available. Fire tested and Lloyd's certified in accordance with API 16D.

### Materials:

- coupler and nipple: steel
- dust cap & plug: aluminum body with stainless steel bead chain

### Sizes:

- 1/4", 3/8", 1/2", 3/4", 1", 1 1/4", 1 1/2" and 2"

### Interchange Data:

- Stucchi VEP/VEP-HD, DNP PST4/FSI, Holmbury HFT, Parker FET



VEP Series



VEP-BOP Series

## WS & WS-BOP Series Heavy Duty Thread To Connect

### Applications:

- extensively used in a variety of oilfield applications

### Features:

- connect under residual pressure
- durable sleeve is cast using a process that provides improved surface finishes, tighter tolerances, and excellent repeatability
- heavy duty "spider" valve holder withstands surge flow and pressurized connections
- seals are easily field replaceable
- Blow-out prevention (BOP) version available. Fire tested and Lloyd's certified in accordance with API 16D.

### Materials:

- coupler and nipple: steel or 316 stainless
- dust cap & plug: aluminum body with stainless steel bead chain

### Sizes:

- 3/4", 1", 1 1/4", 1 1/2" and 2"

### Interchange Data:

- Snap-Tite 75, Hydraulics Inc 5TV, Stucchi VOF, DNP VFF-HD, Faster OGV, Eaton FD85



WS Series

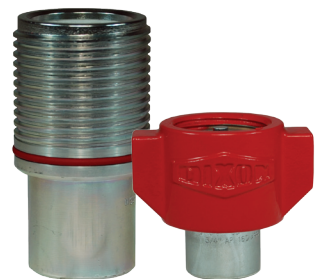

WS-BOP Series

# Hydraulic Quick Disconnects

## W-Series

### 7800 Wingstyle Interchange

**Application:**

- used to connect hydraulic lines on oilfield equipment such as tongs, swivels, and other drill rig applications

**Features:**

- threaded wing or hex sleeves enable easy connection and disconnection while under residual pressure
- O-ring connected marker is highly visible during connection and helps keep contaminants out of the threads while connected
- coupler has a tubular valve design to reduce pressure drop and turbulence while improving flow performance
- bulkhead mounting kits available
- flanged bonded seal prolongs coupling life and is integral in the reduction of spillage and air inclusion



**Materials:**

- coupler and nipple: brass, steel wing nut
- dust cap & plug: steel body with stainless steel bead chain
- nipple mounting flange: steel

**Sizes:**

- ¾", 1", 1¼" and 1½"

**Interchange Data:**

- Eaton 5100, Parker 6100, Snap-Tite 78, Safeway S51, Stucchi W

## HT-Series

### ISO 16028 Flush Face Interchange

**Application:**

- no-spill coupling used to connect hydraulic lines on construction equipment, hydraulic tools, and other hydraulic systems

**Features:**

- patented coupler retention system prevents valve stem ejection during surge flow and pressure spike conditions while maximizing flow performance
- high strength laser-cut valve guide in nipple improves valve stability while minimizing flow restriction
- designed to exceed 1,000,000 impulse cycles both connected and disconnect
- bulkhead mountable grooved sleeve for breakaway, multi-plate or blindmate installations
- easily rebuildable coupler and nipple



**Materials:**

- coupler and nipple: steel or 316 stainless
- dust cap & plug: elastomer

**Sizes:**

- ¼", ⅜", ½", ⅝", ¾", 1", 1½", and 2"

**Interchange Data:**

- Parker FEM, Eaton FD89, Stucchi FIRG/Series A, Faster FFH, Safeway FF49

# Hydraulic Quick Disconnects

## ST-Series Flush Face 71 Interchange

### Application:

- use in hydraulic applications where a no-spill coupling with higher working pressures and rugged design is required

### Features:

- flush face valve design minimizes air inclusion during connection and spillage during disconnection
- heavy duty construction for abusive applications
- bulkhead mountable grooved sleeve for breakaway, multi-plate or blindmate installations

### Materials:

- coupler and nipple: steel or 316 stainless
- dust cap & plug: aluminum body with stainless steel bead chain

### Sizes:

- ¼", ⅜", ½", ¾", 1" and 2"

### Interchange Data:

- Snap-Tite 71-Series



---

## T-Series 3000 High Pressure Thread To Connect Interchange

### Application:

- designed for high pressure applications such as hydraulic rams and pumps where pressure up to 10,000 PSI is possible

### Features:

- threaded sleeve allows connection and disconnection while coupler and/or nipple are under pressure
- urethane seal resists extrusion under high pressure
- ball valve and poppet valve styles available

### Materials:

- coupler and nipple: steel or 316 stainless
- dust cap: steel body with stainless steel bead chain
- dust plug: steel body with elastomer lanyard

### Sizes:

- ¼" and ⅜"

### Interchange Data:

- Parker/Pioneer 3000, Enerpac C604, Stucchi IVHP, DNP PVM



Enerpac® is a registered trademark of the Enerpac Company



# Hydraulic Quick Disconnects

## H & H-BOP Series ISO 7241 Series B Industrial Hydraulic Series



H Series



H-BOP Series

**Application:**

- double shut-off coupling used in a wide variety of hydraulic applications where fluid transfer lines need to be connected and disconnected with minimal fluid loss

**Features:**

- variety of body and seal materials for versatility in a wide array of applications
- steel coupler sleeves and nipples are hardened to provide heavy duty performance and resist brinelling
- brass and BOP couplers have a redundant O-ring sealing system
- Blow-out prevention (BOP) version available. Fire tested and Lloyd's certified in accordance with API 16D.

**Sizes:**

- 1/8", 1/4", 3/8", 1/2", 3/4", 1", 1 1/4", 1 1/2" and 2 1/2"

**Materials:**

- coupler and nipple: steel, brass, 303 stainless or 316 stainless
- dust cap & plug: aluminum body with stainless steel bead chain, elastomer

**Interchange Data:**

- Parker 60, Hansen HK, Eaton FD45, Faster HNV, Stucchi IRB/IRBO/IRBX

## K-Series ISO 7241 Series A 5600 Mobile General Purpose Series

**Application:**

- double shut-off coupling used in a wide variety of hydraulic applications where hoses need to be connected and disconnected with minimal fluid loss

**Features:**

- steel componentry is plated using ROHS compliant trivalent chrome
- heavy duty knurled sleeves are hardened to resist deformation and maximize service life
- nipples are hardened to resist brinelling

**Materials:**

- coupler and nipple: steel
- dust cap & plug: elastomer

**Sizes:**

- 1/4", 3/8", 1/2", 3/4", 1", 1 1/4", 1 1/2" and 2"

**Interchange Data:**

- Parker 6600, Eaton FD56 (5600), Faster ANV, Safeway S56, Stucchi BIR



## V-Series

### General Purpose H/IH Interchange

**Application:**

- general purpose coupling for hydraulic and pneumatic service

**Features:**

- compliant with MIL-C-51234
- available in single shut-off, double shut-off, or straight through valve configurations for a variety of applications
- wide array of materials and end configurations

**Materials:**

- coupler and nipple: steel, brass or 316 stainless
- dust cap & plug: aluminum body with stainless steel bead chain, elastomer

**Sizes:**

- 1/4", 3/8", 1/2", 3/4", 1", 1 1/4", 1 1/2" and 2"

**Interchange Data:**

- Snap-Tite H/IH, Faster TNV/TNL

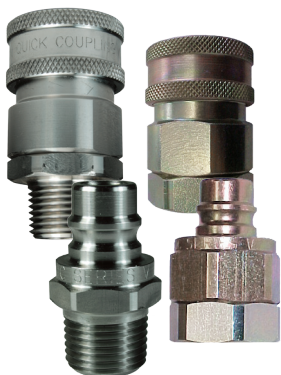

# Hydraulic Adapters

• additional adapters and configurations available, call Dixon or visit [dixonvalve.com](http://dixonvalve.com) for more information



45° male NPTF x female NPSM swivel



male 37° flare x male SAE O-ring



JIC male 37° flare x male NPTF



SAE 61 x male JIC



female NPTF x male NPTF branch tee

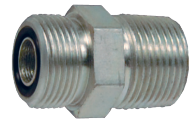

male flat face x male NPTF

# Air & Water Utilities



Air King Couplings  
*couplers, ferrules and clamps*



Pneumatic Couplers  
*air supply, testing equipment and blow guns*



Filters, Regulators, & Lubricators  
*combination units, repair kits*



Gauges  
*digital, liquid filled and dry*



Fire Hose and Reels  
*nozzles, racks and safety equipment*



PTFE Assemblies  
*hose, couplings and fittings*

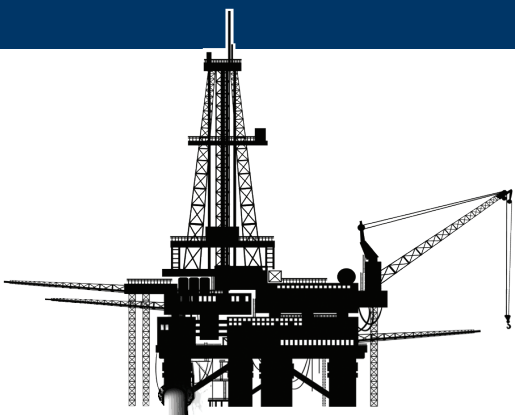

## EXPLORATION/ PRODUCTION

### Pet•ro•chem•i•cal

*noun*

Any chemical derived from petroleum or natural gas.

Many countries, many cultures, but the same Petrochemical Life Cycle applications using DIXON products for safe and reliable fluid transfer.

Popular brands include... Boss, Bayco, Holedall, King, and more...



## TRANSPORTATION



## REFINING



## TRANSPORTATION

1



### Exploration and Production

- Boss Low Pressure System Products
- Frac Fittings
- King Crimp System
- Hammer Unions
- Control Valves
- Holedall Couplings
- Tank Truck and Rail Car/API Fittings & Assemblies

2

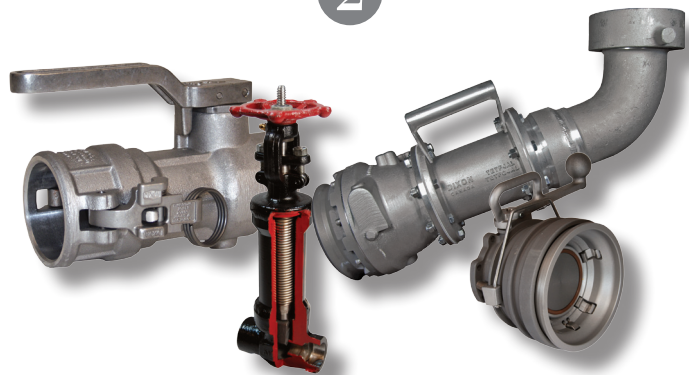

### Refining

- Dry Break Couplings
- Cam & Groove
- Dry Disconnects
- Ground Joint Systems
- Valves
- API Fittings

# THE PETROCHEMICAL LIFE CYCLE



## Terminal to Retail

- Overfill Protection
- Loading/Unloading
- Adapters
- Vapor Elbows
- Swivels
- Tank Truck and Rack Fittings
- Nozzles



Scan for more information on the  
petrochemical life cycle



Dixon is recognized as the premier manufacturer and supplier of hose fittings and accessories spanning a wide range of industrial uses. Dixon's range includes products for food, dairy processing, beverage and brewery, mobile tankers, mining, construction, chemical processing, petroleum, oilfields, refining and manufacturing.

[dixonvalve.com](http://dixonvalve.com) • *Customer Service:* 877.963.4966



*The Right Connection®*

**Dixon**

800 High Street, Chestertown, MD 21620  
fx: 800.283.4966



YouTube™



Dixon  
Customer Service