

Actual Size Profile Chart

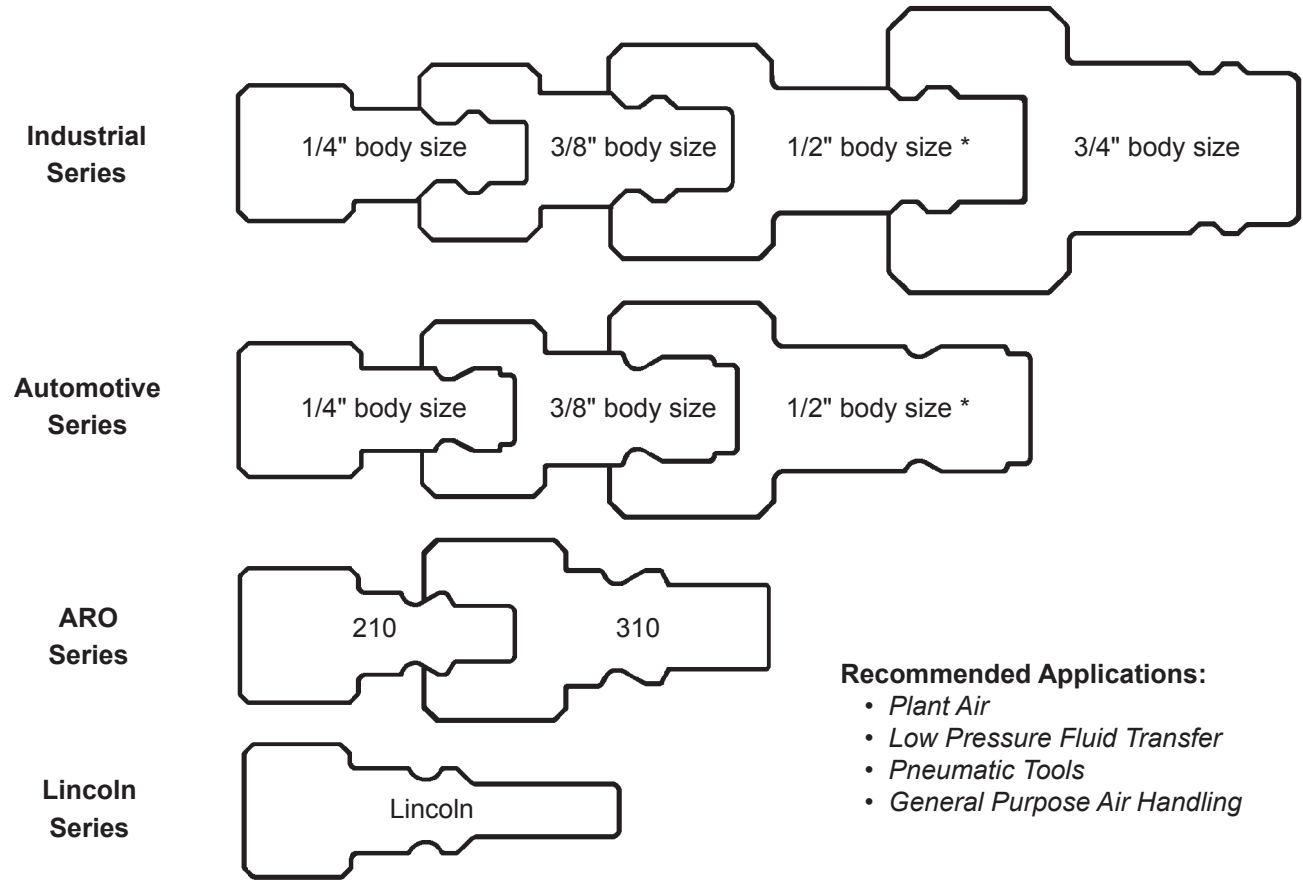

Recommended Applications:

- Plant Air
- Low Pressure Fluid Transfer
- Pneumatic Tools
- General Purpose Air Handling

* 1/2" industrial series may also interchange with 1/2" automotive series

SAFETY



A short length whip hose is recommended on impact tools connected with these couplers to prevent premature wear caused by excessive vibration.

Dixon's couplings and retention devices are designed to work safely for their intended use. The selection of the proper hose, coupling and retention device, and the proper application of the coupling to the hose are of utmost importance.

Users must consider the size, temperature, application, media, pressure and hose and coupling manufacturer's recommendations when selecting the proper hose assembly components. Dixon recommends that all hose assemblies be tested in accordance with the Rubber Manufacturers Association's recommendations and be inspected regularly (before each use) to ensure that they are not damaged or have become loose.

Where safety devices are integral to the coupling, they must be working and utilized. The use of supplementary safety devices such as safety clips or safety cables are recommended.

If any problem is detected, couplings must be removed from service immediately.

Dixon is available to consult, train and recommend the proper selection and application of all fittings we sell. We strongly recommend that distributors and end users make use of Dixon's Testing and Recommendation Services. Dixon can be contacted at 877-963-4966.

Semi-Automatic Design

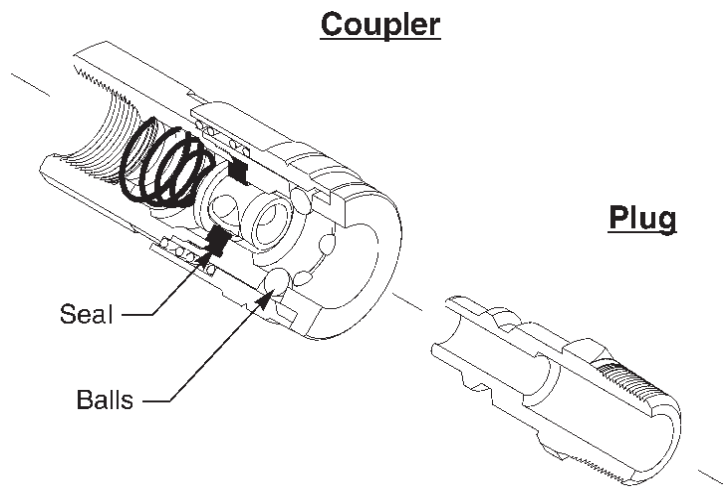

Semi-Automatic Quick-Connect Couplers are generally accepted as the fastest, easiest and most reliable means of joining low pressure pneumatic lines.

Hardened balls or pins engage a groove in the coupler plug to hold it securely against a soft positive seal gasket. This also permits the assembly to swivel, which helps to prevent kinking or twisting of the hose. A sliding sleeve releases the locking balls or pins when retracted, permitting the plug to be inserted or removed. The sleeve automatically returns to the locked position when released. An automatic shut-off valve in the coupler seals when being uncoupled, eliminating the need for a separate shut-off.

Automatic Design

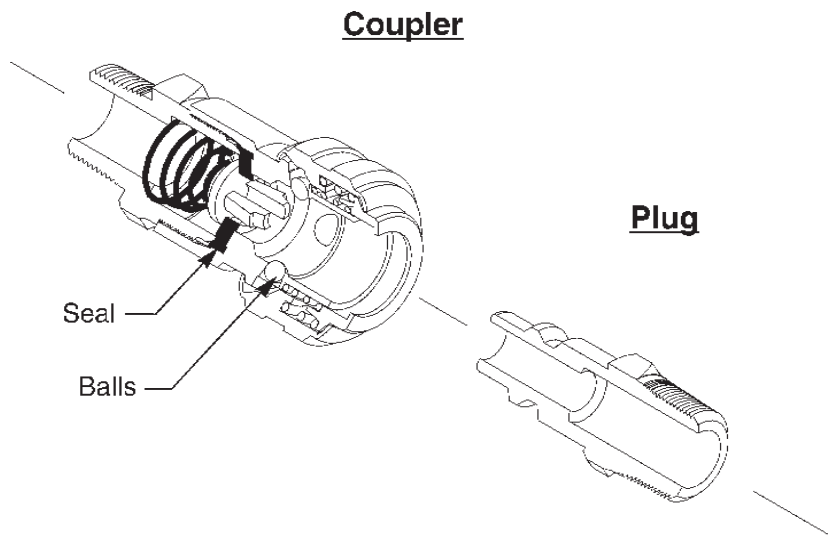

The Automatic Quick-Connect coupling design allows the user to connect and disconnect the fitting with one hand. The sleeve action is designed opposite of the conventional design which reduces the chance of accidental disconnect when pulled across obstacles.

Air Chief Universal Couplers

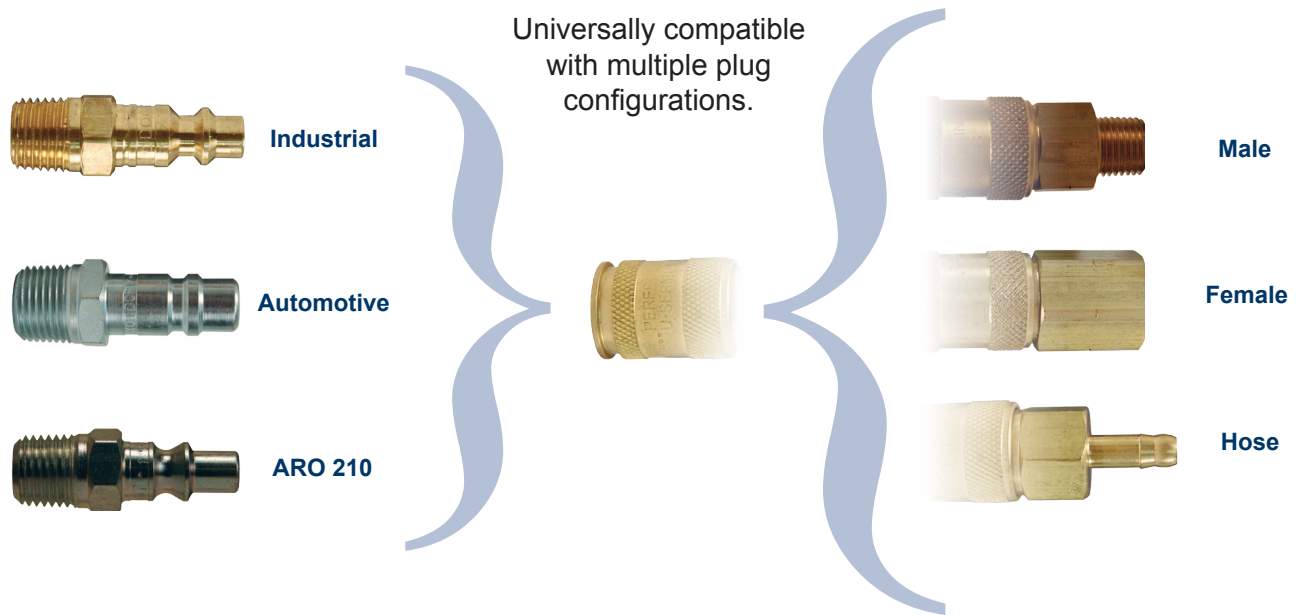

Air Chief Universal Quick-Connect Fittings

U-series are the first 6-in-1 couplers, works with: ARO 210, MIL-C-4109F, Truflate, Lincoln, Italian Standard and CEJN 320. Euro-style valving ensures maximum flow performance and automatic connection with minimal force required. Couplers have a sleeve-guard lip to reduce the risk of accidental disconnection while in service.

automatic - push to connect

Body Size	NPT Thread Size	Material	Flow Rating at 100 PSI	Part #	Female Pipe Thread 
1/4"	1/4"	brass	37 CFM	UDC20	
1/4"	3/8"	brass	37 CFM	UDC2023	

Body Size	NPT Thread Size	Material	Flow Rating at 100 PSI	Part #	Male Pipe Thread 
1/4"	1/4"	brass	37 CFM	UDC21	
1/4"	3/8"	brass	37 CFM	UDC2103	

Body Size	Hose ID	Material	Flow Rating at 100 PSI	Part #	Standard Hose Barb 
1/4"	1/4"	brass	37 CFM	UDC2042	
1/4"	3/8"	brass	37 CFM	UDC2044	

Ball Swivels

1/4" Ball Swivel Plugs

- material:
 - threaded portion is brass
 - plug and nut portion is nickel-plated hardened steel
- rated 250 PSI

Size	Part #
1/4"	DCP21SWIV

Male NPT Ball Swivel x Industrial Plug

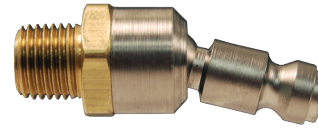

Size	Part #
1/4"	DCP37SWIV

Male NPT Ball Swivel x ARO Plug

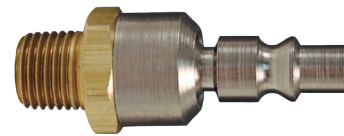

Size	Part #
1/4"	DCP1SWIV

Male NPT Ball Swivel x Automotive Plug

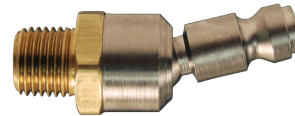

Standard Ball Swivels

- brass and hardened steel construction
- O-ring seals
- wobble action for increased flexibility with air driven tools

Hose Size	Male NPT	Part #
1/4"	1/4"	D444S
3/8"	1/4"	D446S

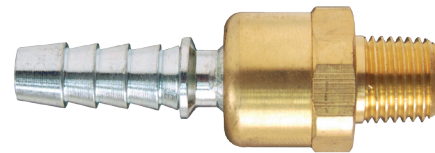

Push-On Ball Swivels

- special barb design for secure grip in push-on type air hoses

Hose Size	Male NPT	Part #
1/4"	1/4"	D444SL
3/8"	1/4"	D446SL

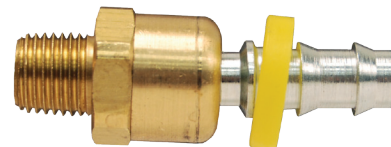



Air Chief Automotive Interchange Quick-Connect Plugs

Air Chief automotive quick-connect plugs will interchange with the popular makes of automotive quick-connect fittings such as Amflo, Dill, Milton and Truflate. There are some makes however, which do not interchange with any others. If you plan to interchange these couplings, make sure you have plug ends with the proper configuration.

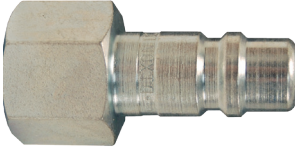
- rated **300 PSI**
- temperature range: **-40°F to 250°F**

Female Pipe Thread	Body Size	NPT Thread Size	Material	Flow Rating at 100 PSI	Part #
		1/4"	1/8"	steel	37 CFM
	1/4"	1/4"	steel	37 CFM	DCP2
	1/4"	3/8"	steel	37 CFM	DCP223
	3/8"	1/4"	steel	70 CFM	DCP8
	3/8"	3/8"	steel	70 CFM	DCP6
	3/8"	1/2"	steel	70 CFM	DCP624
	1/2"	3/8"	steel	150 CFM	DCP1823
	1/2"	1/2"	steel	150 CFM	DCP18
	1/2"	3/4"	steel	150 CFM	DCP1826

Male Pipe Thread	Body Size	NPT Thread Size	Material	Flow Rating at 100 PSI	Part #
		1/4"	1/8"	steel	37 CFM
	1/4"	1/4"	steel	37 CFM	DCP1
	1/4"	3/8"	steel	37 CFM	DCP103
	3/8"	1/4"	steel	70 CFM	DCP7
	3/8"	3/8"	steel	70 CFM	DCP5
	1/2"	3/8"	steel	150 CFM	DCP1703
	1/2"	1/2"	steel	150 CFM	DCP17
	1/2"	3/4"	steel	150 CFM	DCP1706

Standard Hose Barb	Body Size	Hose ID	Material	Flow Rating at 100 PSI	Part #
		1/4"	1/4"	steel	37 CFM
	1/4"	3/8"	steel	37 CFM	DCP144
	3/8"	1/4"	steel	70 CFM	DCP542
	3/8"	3/8"	steel	70 CFM	DCP544
	1/2"	3/8"	steel	150 CFM	DCP1744
	1/2"	1/2"	steel	150 CFM	DCP1745
	1/2"	3/4"	steel	150 CFM	DCP1746

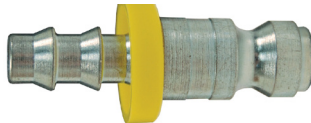
Push-On Hose Barb	Body Size	Hose ID	Material	Flow Rating at 100 PSI	Part #
		1/4"	1/4"	steel	37 CFM
	1/4"	3/8"	steel	37 CFM	DCP144L
	3/8"	3/8"	steel	70 CFM	DCP544L

Air Chief Automotive Interchange Quick-Connect Couplers

Air Chief automotive quick-connect couplers will interchange with the popular makes of automotive quick-connect fittings such as Amflo, Dill, Milton and Truflate. There are some makes however, which do not interchange with any others. If you plan to interchange these couplings, make sure you have plug ends with the proper configuration.

- rated **300 PSI**
- temperature range: **-40°F to 250°F**

Body Size	NPT Thread Size	Material	Flow Rating at 100 PSI	Part #	Female Pipe Thread semi-automatic pull sleeve to connect
1/4"	1/8"	<i>brass</i>	37 CFM	DC221	
1/4"	1/4"	<i>brass</i>	37 CFM	DC2	
1/4"	3/8"	<i>brass</i>	37 CFM	DC223	
3/8"	1/4"	<i>steel</i>	70 CFM	DC8	
3/8"	3/8"	<i>steel</i>	70 CFM	DC6	
3/8"	1/2"	<i>steel</i>	70 CFM	DC624	
1/2"	3/8"	<i>steel</i>	150 CFM	DC1023	
1/2"	1/2"	<i>steel</i>	150 CFM	DC10	
1/2"	3/4"	<i>steel</i>	150 CFM	DC1026	

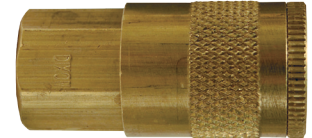

Body Size	NPT Thread Size	Material	Flow Rating at 100 PSI	Part #	Male Pipe Thread semi-automatic pull sleeve to connect
1/4"	1/8"	<i>brass</i>	37 CFM	DC101	
1/4"	1/4"	<i>brass</i>	37 CFM	DC1	
1/4"	3/8"	<i>brass</i>	37 CFM	DC103	
3/8"	1/4"	<i>steel</i>	70 CFM	DC7	
3/8"	3/8"	<i>steel</i>	70 CFM	DC5	
3/8"	1/2"	<i>steel</i>	70 CFM	DC504	
1/2"	3/8"	<i>steel</i>	150 CFM	DC903	
1/2"	1/2"	<i>steel</i>	150 CFM	DC9	
1/2"	3/4"	<i>steel</i>	150 CFM	DC906	

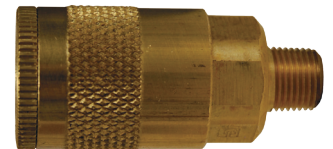

Body Size	Hose ID	Material	Flow Rating at 100 PSI	Part #	Standard Hose Barb semi-automatic pull sleeve to connect
1/4"	1/4"	<i>brass</i>	37 CFM	DC242	
1/4"	5/16"	<i>brass</i>	37 CFM	DC243	
1/4"	3/8"	<i>brass</i>	37 CFM	DC244	
3/8"	1/4"	<i>steel</i>	70 CFM	DC642	
3/8"	3/8"	<i>steel</i>	70 CFM	DC644	
3/8"	1/2"	<i>steel</i>	70 CFM	DC645	
1/2"	3/8"	<i>steel</i>	150 CFM	DC1044	
1/2"	1/2"	<i>steel</i>	150 CFM	DC1045	
1/2"	3/4"	<i>steel</i>	150 CFM	DC1046	



Body Size	Hose ID	Material	Flow Rating at 100 PSI	Part #	Push-On Hose Barb semi-automatic pull sleeve to connect
1/4"	1/4"	<i>brass</i>	37 CFM	DC242L	
1/4"	3/8"	<i>brass</i>	37 CFM	DC244L	
3/8"	1/4"	<i>steel</i>	70 CFM	DC642L	
3/8"	3/8"	<i>steel</i>	70 CFM	DC644L	

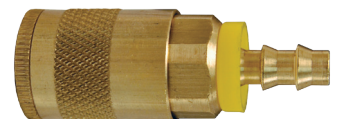

Air Chief Industrial Interchange Quick-Connect Couplers

Air Chief industrial quick-connect couplers are the popular Industrial Interchange design and will interchange with many other makes. Couplers shut-off when disconnected.

- rated to **300 PSI**
- temperature range: **-40°F to 250°F**
- *for air service only*
- interchanges with MIL Spec. MIL-C-4109F/A-A-59439

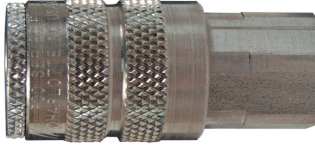
Female Pipe Thread	Body Size	NPT Thread Size	Material	Flow Rating at 100 PSI	Part #
	 <p>semi-automatic pull sleeve to connect</p>	1/4"	1/8"	brass	37 CFM
1/4"		1/4"	brass	37 CFM	DC20
1/4"		3/8"	brass	37 CFM	DC2023
3/8"		1/4"	steel	70 CFM	DC2622
3/8"		3/8"	steel	70 CFM	DC26
3/8"		1/2"	steel	70 CFM	DC2624
1/2"		3/8"	steel	150 CFM	DC1023
1/2"		1/2"	steel	150 CFM	DC10
1/2"		3/4"	steel	150 CFM	DC1026
3/4"		1/2"	brass	200 CFM	DC7024 ¹
3/4"		3/4"	brass	200 CFM	DC7026 ¹
3/4"		1"	brass	200 CFM	DC7028 ¹
1/4"		1/4"	303 stainless	37 CFM	DC20S
3/8"		3/8"	303 stainless	70 CFM	DC26S
1/2"		1/2"	303 stainless	150 CFM	DC10S

¹ 3/4" are automatic sleeve

Male Pipe Thread	Body Size	NPT Thread Size	Material	Flow Rating at 100 PSI	Part #
	 <p>semi-automatic pull sleeve to connect</p>	1/4"	1/8"	brass	37 CFM
1/4"		1/4"	brass	37 CFM	DC21
1/4"		3/8"	brass	37 CFM	DC2103
3/8"		1/4"	steel	70 CFM	DC2502
3/8"		3/8"	steel	70 CFM	DC25
3/8"		1/2"	steel	70 CFM	DC2504
1/2"		3/8"	steel	150 CFM	DC903
1/2"		1/2"	steel	150 CFM	DC9
1/2"		3/4"	steel	150 CFM	DC906
3/4"		1/2"	brass	200 CFM	DC7104 ¹
3/4"		3/4"	brass	200 CFM	DC7106 ¹
3/4"		1"	brass	200 CFM	DC7108 ¹
1/4"		1/4"	303 stainless	37 CFM	DC21S
3/8"		3/8"	303 stainless	70 CFM	DC25S
1/2"		1/2"	303 stainless	150 CFM	DC9S

¹ 3/4" are automatic sleeve

Standard Hose Barb	Body Size	Hose ID	Material	Flow Rating at 100 PSI	Part #
	 <p>semi-automatic pull sleeve to connect</p>	1/4"	1/4"	brass	37 CFM
1/4"		5/16"	brass	37 CFM	DC2043
1/4"		3/8"	brass	37 CFM	DC2044
3/8"		1/4"	steel	70 CFM	DC2642
3/8"		3/8"	steel	70 CFM	DC2644
3/8"		1/2"	steel	70 CFM	DC2645
1/2"		3/8"	steel	150 CFM	DC1044
1/2"		1/2"	steel	150 CFM	DC1045
1/2"		3/4"	steel	150 CFM	DC1046
3/4"		1/2"	brass	200 CFM	DC7045 ¹
3/4"		3/4"	brass	200 CFM	DC7046 ¹
3/4"		1"	brass	200 CFM	DC7048 ¹
1/4"		1/4"	303 stainless	37 CFM	DC2042S
3/8"		3/8"	303 stainless	70 CFM	DC2644S
1/2"		1/2"	303 stainless	150 CFM	DC1045S

¹ 3/4" are automatic sleeve

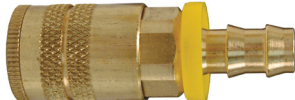
Push-On Hose Barb	Body Size	Hose ID	Material	Flow Rating at 100 PSI	Part #
	 <p>semi-automatic pull sleeve to connect</p>	1/4"	1/4"	brass	37 CFM
1/4"		3/8"	brass	37 CFM	DC2044L
3/8"		1/4"	steel	70 CFM	DC2642L
3/8"		3/8"	steel	70 CFM	DC2644L

Air Chief Industrial Interchange Quick-Connect Couplers

Air Chief industrial quick-connect couplers are the popular industrial interchange design and will interchange with many other makes. Couplers shut-off when disconnected.

- rated to **300 PSI**
- temperature range: **-40°F to 250°F**
- *for air service only*
- interchanges with MIL Spec. MIL-C-4109F/A-A-59439

Body Size	Female NPT	Material	Flow Rating at 100 PSI	Part #	Female Pipe Thread
1/4"	1/4"	brass	27 CFM	DCB20	
1/4"	3/8"	brass	27 CFM	DCB2023	
3/8"	1/4"	brass	45 CFM	DCB2622	
3/8"	3/8"	brass	45 CFM	DCB26	
3/8"	1/2"	brass	45 CFM	DCB2624	
1/2"	3/8"	brass	91 CFM	DCB1023	
1/2"	1/2"	brass	91 CFM	DCB10	
1/2"	3/4"	brass	91 CFM	DCB1026	
3/4"	1/2"	brass	200 CFM	DC7024	
3/4"	3/4"	brass	200 CFM	DC7026	
3/4"	1"	brass	200 CFM	DC7028	
1/4"	1/4"	303 stainless	37 CFM	DCS20	
3/8"	3/8"	303 stainless	70 CFM	DCS26	
1/2"	1/2"	303 stainless	150 CFM	DCS10	

Body Size	NPT Thread Size	Material	Flow Rating at 100 PSI	Part #	Male Pipe Thread
1/4"	1/4"	brass	27 CFM	DCB21	
1/4"	3/8"	brass	27 CFM	DCB2103	
3/8"	1/4"	brass	45 CFM	DCB2502	
3/8"	3/8"	brass	45 CFM	DCB25	
3/8"	1/2"	brass	45 CFM	DCB2504	
1/2"	3/8"	brass	91 CFM	DCB903	
1/2"	1/2"	brass	91 CFM	DCB9	
1/2"	3/4"	brass	91 CFM	DCB906	
3/4"	1/2"	brass	200 CFM	DC7104	
3/4"	3/4"	brass	200 CFM	DC7106	
3/4"	1"	brass	200 CFM	DC7108	
1/4"	1/4"	303 stainless	37 CFM	DCS21	
3/8"	3/8"	303 stainless	70 CFM	DCS25	
1/2"	1/2"	303 stainless	150 CFM	DCS9	



Body Size	Hose ID	Material	Flow Rating at 100 PSI	Part #	Standard Hose Barb
1/4"	1/4"	brass	27 CFM	DCB2042	
1/4"	3/8"	brass	27 CFM	DCB2044	
3/8"	1/4"	brass	45 CFM	DCB2642	
3/8"	3/8"	brass	45 CFM	DCB2644	
3/8"	1/2"	brass	45 CFM	DCB2645	
1/2"	3/8"	brass	91 CFM	DCB1044	
1/2"	1/2"	brass	91 CFM	DCB1045	
1/2"	3/4"	brass	91 CFM	DCB1046	
3/4"	1/2"	brass	200 CFM	DC7045	
3/4"	3/4"	brass	200 CFM	DC7046	
3/4"	1"	brass	200 CFM	DC7048	
1/4"	1/4"	303 stainless	37 CFM	DCS2042	
3/8"	3/8"	303 stainless	70 CFM	DCS2644	
1/2"	1/2"	303 stainless	150 CFM	DCS1045	

Air Chief Industrial Interchange Quick-Connect Plugs

Air Chief industrial quick-connect plugs are the popular industrial interchange design and will interchange with many other makes. Couplers shut-off when disconnected.

- rated to **300 PSI**
- temperature range: **-40°F to 250°F**
- *for air service only*
- interchanges with MIL Spec. MIL-C-4109F/A-A-59439

Male Pipe Thread	Body Size	NPT Thread Size	Material	Flow Rating at 100 PSI	Part #
	1/4"	1/8"	steel	37 CFM	DCP2101
	1/4"	1/4"	steel	37 CFM	DCP21
	1/4"	3/8"	steel	37 CFM	DCP2103
	3/8"	1/4"	steel	70 CFM	DCP2502
	3/8"	3/8"	steel	70 CFM	DCP25
	3/8"	1/2"	steel	70 CFM	DCP2504
	1/2"	3/8"	steel	150 CFM	DCP1703
	1/2"	1/2"	steel	150 CFM	DCP17
	1/2"	3/4"	steel	150 CFM	DCP1706
	3/4"	1/2"	steel	200 CFM	DCP7104
	3/4"	3/4"	steel	200 CFM	DCP7106
	3/4"	1"	steel	200 CFM	DCP7108
	1/4"	1/8"	brass	37 CFM	DCP2101B
	1/4"	1/4"	brass	37 CFM	DCP21B
	1/4"	3/8"	brass	37 CFM	DCP2103B
	1/4"	1/4"	303 stainless	37 CFM	DCP21S
	3/8"	3/8"	303 stainless	70 CFM	DCP25S
	1/2"	1/2"	303 stainless	150 CFM	DCP17S

Standard Hose Barb	Body Size	Hose ID	Material	Flow Rating at 100 PSI	Part #
  DCP7145	1/4"	1/4"	steel	37 CFM	DCP2142
	1/4"	5/16"	steel	37 CFM	DCP2143
	1/4"	3/8"	steel	37 CFM	DCP2144
	3/8"	1/4"	steel	70 CFM	DCP2542
	3/8"	3/8"	steel	70 CFM	DCP2544
	3/8"	1/2"	steel	70 CFM	DCP2545
	1/2"	3/8"	steel	150 CFM	DCP1744
	1/2"	1/2"	steel	150 CFM	DCP1745
	1/2"	3/4"	steel	150 CFM	DCP1746
	3/4"	1/2"	steel	200 CFM	DCP7145
	3/4"	3/4"	steel	200 CFM	DCP7146
	3/4"	1"	steel	200 CFM	DCP7148
	1/4"	1/4"	brass	37 CFM	DCP2142B
	1/4"	3/8"	brass	37 CFM	DCP2144B
	1/4"	1/4"	303 stainless	37 CFM	DCP2142S
	3/8"	3/8"	303 stainless	70 CFM	DCP2544S
	1/2"	1/2"	303 stainless	150 CFM	DCP1745S

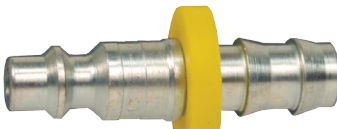
Push-On Hose Barb	Body Size	Hose ID	Material	Flow Rating at 100 PSI	Part #
	1/4"	1/4"	steel	37 CFM	DCP2142L
	1/4"	3/8"	steel	37 CFM	DCP2144L
	3/8"	1/4"	steel	70 CFM	DCP2542L
	3/8"	3/8"	steel	70 CFM	DCP2544L

Air Chief Industrial Interchange Quick-Connect Plugs

Air Chief industrial quick-connect plugs are the popular industrial interchange design and will interchange with many other makes. Couplers shut-off when disconnected.

- rated to **300 PSI**
- temperature range: **-40°F to 250°F**
- *for air service only*
- interchanges with MIL Spec. MIL-C-4109F/A-A-59439

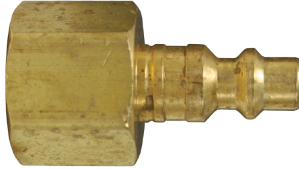
Body Size	NPT Thread Size	Material	Flow Rating at 100 PSI	Part #	Female Pipe Thread
1/4"	1/8"	steel	37 CFM	DCP2021	
1/4"	1/4"	steel	37 CFM	DCP20	
1/4"	3/8"	steel	37 CFM	DCP2023	
3/8"	1/4"	steel	70 CFM	DCP2622	
3/8"	3/8"	steel	70 CFM	DCP26	
3/8"	1/2"	steel	70 CFM	DCP2624	
1/2"	3/8"	steel	150 CFM	DCP1823	
1/2"	1/2"	steel	150 CFM	DCP18	
1/2"	3/4"	steel	150 CFM	DCP1826	
3/4"	1/2"	steel	200 CFM	DCP7024	
3/4"	3/4"	steel	200 CFM	DCP7026	
3/4"	1"	steel	200 CFM	DCP7028	
1/4"	1/4"	brass	37 CFM	DCP20B	
1/4"	3/8"	brass	37 CFM	DCP2023B	
1/4"	1/4"	303 stainless	37 CFM	DCP20S	
3/8"	3/8"	303 stainless	70 CFM	DCP26S	
1/2"	1/2"	303 stainless	150 CFM	DCP18S	

Air Chief Lincoln Series Quick-Connect Plugs

These sockets and plugs are interchangeable with Lincoln's long stem series. Couplers shut-off when disconnected.

- rated **300 PSI** at ambient temperature (70°F)

Body Size	NPT Thread Size	Material	Flow Rating at 100 PSI	Part #	Female Pipe Thread
1/4"	1/4"	steel	37 CFM	DCP28	

Body Size	NPT Thread Size	Material	Flow Rating at 100 PSI	Part #	Male Pipe Thread
1/4"	1/4"	steel	37 CFM	DCP27	

Air Chief Lincoln Series Quick-Connect Couplers

These sockets and plugs are interchangeable with Lincoln's long stem series. Couplers shut-off when disconnected.

- rated **300 PSI**
- semi-automatic - pull sleeve to connect

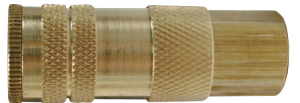
Body Size	NPT Thread Size	Material	Flow Rating at 100 PSI	Part #	Female Pipe Thread
1/4"	1/4"	brass	37 CFM	DC28	

Body Size	NPT Thread Size	Material	Flow Rating at 100 PSI	Part #	Male Pipe Thread
1/4"	1/4"	brass	37 CFM	DC27	

Air Chief ARO Speed Quick-Connect Plugs

These semi-automatic quick connects interchange with both the ARO 210 and 310 design.

- rated **300 PSI** at ambient temperature (70°F)

Female Pipe Thread	Body Size	NPT Thread Size	Material	Flow Rating at 100 PSI	Part #
	1/4"	1/4"	steel	37 CFM	DCP38
	1/4"	3/8"	steel	37 CFM	DCP3823
	3/8"	3/8"	steel	70 CFM	DCP36

Male Pipe Thread	Body Size	NPT Thread Size	Material	Flow Rating at 100 PSI	Part #
	1/4"	1/4"	steel	37 CFM	DCP37
	1/4"	3/8"	steel	37 CFM	DCP3703
	3/8"	3/8"	steel	70 CFM	DCP35

Standard Hose Barb	Body Size	Hose ID	Material	Flow Rating at 100 PSI	Part #
	1/4"	1/4"	steel	37 CFM	DCP3742
	1/4"	3/8"	steel	37 CFM	DCP3744

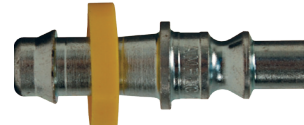
Push-On Hose Barb	Body Size	Hose ID	Material	Flow Rating at 100 PSI	Part #
	1/4"	1/4"	steel	37 CFM	DCP3742L
	1/4"	3/8"	steel	37 CFM	DCP3744L

Air Chief ARO Speed Quick-Connect Couplers

These semi-automatic quick connects interchange with both the ARO 210 and 310 design. Couplers shut-off when disconnected.

- rated **300 PSI** at ambient temperature (70°F)

semi-automatic - pull sleeve to connect

Female Pipe Thread	Body Size	NPT Thread Size	Material	Flow Rating at 100 PSI	Part #
	1/4"	1/4"	brass	37 CFM	DC38
	1/4"	3/8"	brass	37 CFM	DC3823
	3/8"	3/8"	steel	70 CFM	DC36

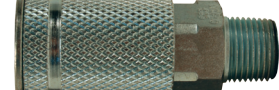
Male Pipe Thread	Body Size	NPT Thread Size	Material	Flow Rating at 100 PSI	Part #
	1/4"	1/4"	brass	37 CFM	DC37
	1/4"	3/8"	brass	37 CFM	DC3703
	3/8"	3/8"	steel	70 CFM	DC35

Standard Hose Barb	Body Size	Hose ID	Material	Flow Rating at 100 PSI	Part #
	1/4"	1/4"	steel	37 CFM	DC3842
	1/4"	3/8"	steel	37 CFM	DC3844

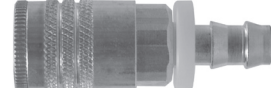
Push-On Hose Barb	Body Size	Hose ID	Material	Flow Rating at 100 PSI	Part #
	1/4"	1/4"	brass	37 CFM	DC3842L
	1/4"	3/8"	brass	37 CFM	DC3844L

Air Chief A Series Quick-Connect Plugs

Air Chief A series are intended for use in compressed air service where the convenience of one hand operation and a compact profile is desired. Machined from solid brass bar stock, stainless steel balls and springs maximize corrosion resistance.

- maximum working pressure: **500 PSI** at ambient temperature (70°F)

Body Size	NPT Thread Size	Material	Flow Rating at 100 PSI	Part #	Female Pipe Thread 
1/8"	1/8"	<i>brass</i>	7 CFM	A1F1-B	
1/4"	1/4"	<i>brass</i>	25 CFM	A2F2-B	

Body Size	NPT Thread Size	Material	Flow Rating at 100 PSI	Part #	Male Pipe Thread 
1/8"	1/8"	<i>brass</i>	7 CFM	A1M1-B	
1/4"	1/4"	<i>brass</i>	25 CFM	A2M2-B	

Body Size	Hose ID	Material	Flow Rating at 100 PSI	Part #	Hose Barb 
1/8"	1/8"	<i>brass</i>	7 CFM	A1S1-B	

Air Chief A Series Quick-Connect Couplers

automatic - push to connect

Body Size	NPT Thread Size	Material	Flow Rating at 100 PSI	Part #	Female Pipe Thread 
1/8"	1/8"	<i>brass</i>	7 CFM	1AF1-B	
1/4"	1/4"	<i>brass</i>	25 CFM	2AF2-B	

Body Size	NPT Thread Size	Material	Flow Rating at 100 PSI	Part #	Male Pipe Thread 
1/8"	1/8"	<i>brass</i>	7 CFM	1AM1-B	
1/4"	1/4"	<i>brass</i>	25 CFM	2AM2-B	

Body Size	Hose ID	Material	Flow Rating at 100 PSI	Part #	Hose Barb 
1/8"	1/8"	<i>brass</i>	7 CFM	1AS1-B	
1/4"	1/4"	<i>brass</i>	25 CFM	2AS2-B	

Air Chief Safety Blow Gun

This basic safety blow gun is designed to conform to OSHA Standard 1910.242 (B) permitting a maximum of 30 PSI outlet pressure when dead ended based on a maximum of 150 PSI inlet pressure as well as OSHA Standard 1910.95 regulating occupational noise level exposure. *Safety glasses or shield must be worn when using any blow gun.*

SAFETY
ALERT

- Blow gun body is designed to comfortably fit the contour of the hand, minimizing user fatigue.
- Large lever with black vinyl grip further adds to the ergonomic design and allows for easy air flow activation.
- Recessed internal slotted screw allows easy access to valve assembly for repairs or replacement.
- Chrome plated zinc die cast body, nickel plated steel lever, vinyl thumb grip, stainless steel spring, brass valve, Buna-N seals and nickel plated brass tip combine for superior corrosion resistance as well as a contemporary look.
- ¼" female NPT inlet



Part #

D204-30

Premium Safety Blow Gun

- Blow gun body is designed to comfortably fit the contour of the hand, minimizing user fatigue.
- Large lever with vinyl grip further adds to the ergonomic design and allows for easy air flow activation.
- Zinc die cast body with a black powder coat finish, nickel plated steel lever, vinyl thumb grip, stainless steel spring, brass valve, Buna-N seals and nickel plated brass tip.
- ¼" female NPT inlet

Safety glasses or shield must be worn when using any blow gun.

SAFETY
ALERT



Part #

D204-30P

Safety Air Booster Blow Gun

The multiple holes in the safety booster tip of the safety air booster gun create a venturi effect that increases air flow (working capacity) while still remaining compliant with OSHA Standard 1910.242 (B). *Safety glasses or shield must be worn when using any blow gun.*

SAFETY
ALERT

- Blow gun body is designed to comfortably fit the contour of the hand, minimizing user fatigue.
- Large lever with vinyl grip further adds to the ergonomic design and allows for easy air flow activation.
- Chrome plated zinc die cast body, nickel plated steel lever, vinyl thumb grip, stainless steel spring, brass valve, Buna-N seals and nickel plated brass Safety Booster tip provide superior corrosion resistance.
- ¼" female NPT inlet



Part #

D204-30SB

Note: The safety blow guns on this page have a safety tip which prevents buildup of tip pressure in the event the outlet is obstructed or "dead ended". They comply with the requirements for OSHA 1910.242 (B) and 1910.95 when used on air lines of 150 PSI or less.

SAFETY
ALERT

Non-Safety Brass Tipped Blow Guns

The ventless, nickel-plated tip provides the most economical means of achieving a concentrated stream of air for many blow-off applications. All other components and design features are the same as our Air Chief safety blow gun (D204-30). *Must be used on air lines having a maximum regulated pressure of 30 PSI in order to comply with OSHA Standard 1910.242 (B). Safety glasses or shield must be worn when using any blow gun.*

SAFETY
ALERT

- Blow gun body is designed to comfortably fit the contour of the hand, minimizing user fatigue.
- Large lever with vinyl grip further adds to the ergonomic design and allows for easy air flow activation.
- Chrome plated zinc die cast body, nickel plated steel lever, vinyl thumb grip, stainless steel spring, brass valve, Buna-N seals and ventless, nickel plated brass tip provide superior corrosion resistance.
- 1/4" female NPT inlet



Part #

D605

Non-Safety Rubber Tipped Blow Guns

The rubber tip will not scratch or mar delicate surfaces. The conical, rubber tip can also be used to create a seal between the blow gun and fluid lines (or any other opening). Base of the tip is nickel-plated brass for additional corrosion resistance. *Must be used on air lines having a maximum regulated pressure of 30 PSI in order to comply with OSHA Standard 1910.242 (B). Safety glasses or shield must be worn when using any blow gun.*

SAFETY
ALERT

- Blow gun body is designed to comfortably fit the contour of the hand, minimizing user fatigue.
- Large lever with vinyl grip further adds to the ergonomic design and allows for easy air flow activation.
- Chrome plated zinc die cast body, nickel plated steel lever, vinyl thumb grip, stainless steel spring, brass valve, Buna-N seals and rubber tip with a nickel plated brass base provide superior corrosion resistance.
- 1/4" female NPT inlet



Part #

D201

SAFETY
ALERT

Caution: The non-safety blow guns on this page **do not** have a safety by-pass to prevent buildup of tip pressure in the event of tip blockage. They may be used for cleaning purposes only if the air supply (inlet pressure) has been reduced to 30 PSI or less.

Pistol Grip Safety Blow Gun

- conforms to U.S. Department of Labor, OSHA Standard 1910.242 (B) allowing a maximum of 30 PSI outlet pressure at the nozzle when dead-ended
- conforms to U.S. Department of Labor, OSHA Standard 1910.95 regulating noise level exposure
- conforms to Title 41, Walsh-Healy Rules and Regulations P50-204.8, Safety and Health Standards
- Contoured pistol-grip for safe, comfortable handling, even with greasy hands.
- convenient hang-up hook
- 1/4" female NPT inlet
- *Safety glasses or shield must be worn when using any blow gun.*

SAFETY
ALERT



Part #

PG700

Extended Nozzle Pistol Grip Safety Blow Gun



- conforms to U.S. Dept. of Labor, OSHA Standard 1910.242 (B) allowing a maximum of 30 PSI outlet pressure at the nozzle when dead-ended
- conforms to U.S. Dept. of Labor, OSHA Standard 1910.95 regulating noise level exposure
- conforms to Title 41, Walsh-Healy Rules and Regulations P50-204.8 Safety and Health Standards
- Slender 4" extended nozzle allows access to hard to reach places and holes as small as .200".
- variable output trigger enables user to control air flow
- Hook design near trigger provides finger protection as well as easy storage.
- lightweight to help minimize user fatigue.
- Side holes allow air to escape if nozzle tip is dead-ended, thus preventing back pressure buildup.
- pressure rating: **150 PSI**
- 1/4" female NPT inlet
- *Safety glasses or shield must be worn when using any blow gun.*

**SAFETY
ALERT**

Part #

ENBG1

Blow Gun Extensions

These extension tips allow easier access to blow-off applications in high or hard to reach places. Supplied with 1/8" male NPT connections. Can be used with all Dixon Air Chief lever operated blow guns as well as most blow guns from other manufacturers. Made from a brass base with a rugged steel extension tube, all nickel plated.



Size Extension	Part #
6"	BGE6
10"	BGE10
12"	BGE12
18"	BGE18
24"	BGE24

Blow Gun Tips

Nickel plated brass safety tip with 1/8" male NPT connection can be used with all Dixon Air Chief lever operated blow guns as well as most blow guns from other manufacturers.

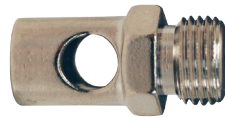

Part #

SST10

Rubber non-safety tip with nickel-plated brass 1/8" male NPT connection can be used with all Dixon Air Chief lever operated blow guns as well as most blow guns from other manufacturers.



Part #

D201RT

Coil-Chief Self-Storing Air Hose

- yellow
- nylon working pressure: **200 PSI at 70°F**
- Coil-Chief comes standard with swivel on one end

bulk hose - no fittings

Hose ID	Length	Part #
1/4"	100'	CC14100B
3/8"	100'	CC38100B
1/2"	100'	CC12100B

Note: bulk hose needs assembly kits for ends

fittings included

Hose ID	Length	Male NPT	Part #
1/4"	12'	1/4"	CC1412
1/4"	25'	1/4"	CC1425
1/4"	50'	1/4"	CC1450
3/8"	25'	3/8"	CC3825
3/8"	50'	3/8"	CC3850
1/2"	25'	1/2"	CC1225
1/2"	50'	1/2"	CC1250



Repair Kits

- Repair / assembly kits include fittings, nut, insert, ferrule and spring guard.

Size	Fitting Type	Part #
1/4"	rigid male	RK090
1/4"	swivel male	RK092
3/8"	rigid male	RK110
3/8"	swivel male	RK112
1/2"	rigid male	RK118
1/2"	swivel male	RK119

Polyurethane Self-Storing Air Hose

Hose ID	Length	Male NPT	Part #
1/4"	10'	1/4"	PU1410
1/4"	15'	1/4"	PU1415
1/4"	25'	1/4"	PU1425
3/8"	15'	3/8"	PU3815
3/8"	20'	3/8"	PU3820
3/8"	25'	3/8"	PU3825
3/8"	50'	3/8"	PU3850
1/2"	15'	1/2"	PU1215

- extremely flexible - resists kinking
- impervious to abrasions, heat and oil
- superior elasticity and coil memory
- blue
- Polyurethane working pressure: **125 PSI at 70°F**
- both ends swivel - fittings included



Repair Kits

Part #	Tubing Size	Price/E	Size	Type	Part #
1/4"	3/8"		1/4"	swivel male	PSM0404
3/8"	9/16"		1/4"	swivel male	PSM0604

Conical Mufflers

Conical mufflers are easy to install, threading the exhaust ports of air tool, valves, cylinders and other pneumatic equipment. They offer an economical method of reducing the noise levels below 90 dBA, conforming with OSHA standards.

- The bronze filter element is rated for 40 micron filtration. The element is bonded directly to the fitting. *These elements are not replaceable.*
- maximum operating pressure: **300 PSI**
- operating temperature: **35°F to 300°F**



NPT Thread Size	Overall Length	Nickel Plated Steel Part #
1/8"	1-1/8"	CMF18
1/4"	1-3/8"	CMF28
3/8"	1-1/2"	CMF38
1/2"	1-7/8"	CMF48
3/4"	2-1/8"	CMF68
1"	2-7/8"	CMF88

Breather Vents

Breather vents have many applications, including vacuum relief or pressure equalization on gear boxes, oil tanks or reservoirs. Common uses can be found on single acting cylinders or valves to prevent dirt and foreign particles from entering ports open to the atmosphere.

- standard pipe thread fittings for quick assembly and removal for cleaning
- nickel plated steel insert with a bronze filter
- The filter element is rated for 40 micron filtration.
- maximum operating pressure: **150 PSI**
- operating temperatures: **35°F to 300°F**



NPT Thread Size	Overall Length	Nickel Plated Steel Part #
1/8"	7/16"	ASP-1BV
1/4"	5/8"	ASP-2BV
3/8"	3/4"	ASP-3BV
1/2"	7/8"	ASP-4BV
3/4"	1"	ASP-6BV
1"	1-5/16"	ASP-8BV

Mini In-Line Lubricators

- can be refilled under line pressure
- oil capacity is 1/4 fluid ounce
- flow rating is 22 SCFM at 100 PSIG
- maximum operating conditions: **200 PSIG** and **175°F**



Female NPT Inlet	NPT Outlet	Aluminum Part #
1/4"	1/4" female	ML200
1/4"	1/4" male	ML200M
3/8"	3/8" male	ML300M

Mini In-Line Filter

- either port may be used as an inlet port
- filter element rated at 5 microns
- flow rating is 17 SCFM inlet pressure at 100 PSIG
- maximum operating conditions: **200 PSIG** and **175°F**

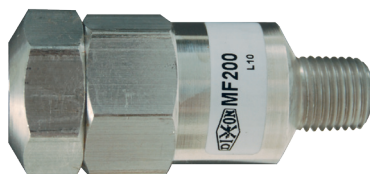

Female NPT	Male NPT	Aluminum Part #
1/4"	1/4"	MF200

Description	Part #
Replacement element	FRP-95-199

Heavy Duty, High Capacity Safety Pop-Off Valves

ASME Code, National Board Certified Safety Valves are designed to protect un-fired pressure vessels from over-pressure.

- all brass construction with chrome steel ball on a precision machined brass seat
- equipped with a pull ring for manual testing
- maximum temperature **400°F (204°C)**

1/2" male NPT		
Preset Pressure PSI	SCFM	Brass Part #
30	73	SV30HD
100	192	SV100HD
125	234	SV125HD
150	277	SV150HD
175	319	SV175HD
200	361	SV200HD

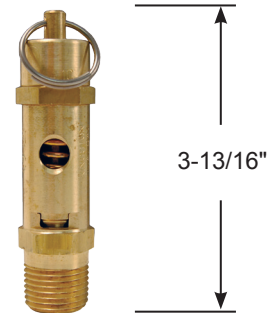

Standard Safety Pop-Off Valves

ASME Code, National Board Certified Safety Valves are designed to protect un-fired pressure vessels from over-pressure.

- Brass valves are supplied with a stainless steel ball.
- Stainless valves are all stainless construction.
- maximum operating temperature is **400°F (204°C)**

1/4" male NPT			
Preset Pressure PSI	SCFM	Brass Part #	Stainless Steel Part #
30	24	SV30	SV30SS
100	64	SV100	SV100SS
125	78	SV125	SV125SS
150	92	SV150	SV150SS
175	106	SV175	SV175SS
200	120	SV200	SV200SS

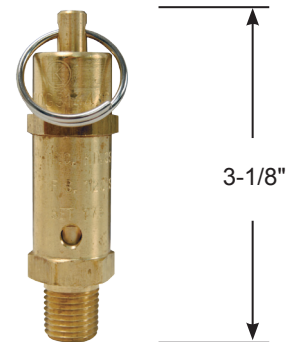

Brass Needle Valves

- metal-to-metal seats allow positive sealing and flow adjustment
- designed for air and water applications
- maximum working pressure: **150 PSI** at ambient temperature (70°F)

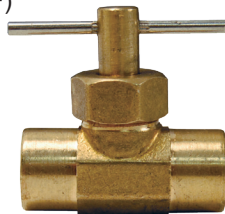

Female NPT	Female NPT	Brass Part #
1/8"	1/8"	NV2F
1/4"	1/4"	NV4F

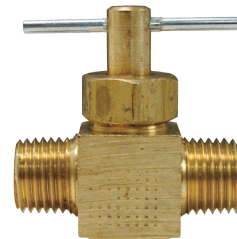

Male NPT	Male NPT	Brass Part #
1/4"	1/4"	NV4M

Bar Manifolds

The bar manifold can be mounted on a wall or work bench, safely distributing four hose lines to a work area.

- maximum working pressure is **300 PSI** at ambient temperature (70°F)
- brass hex head plugs sold separately

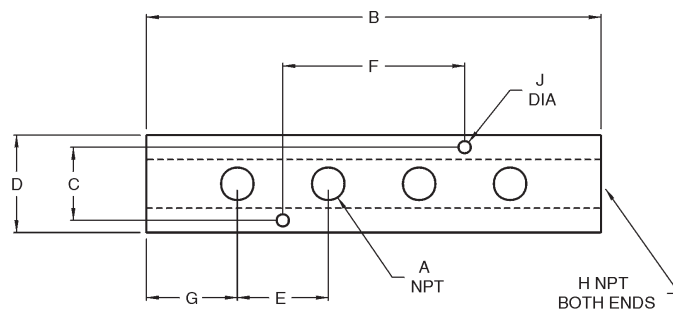

Aluminum Part #	A	B	C	D	E	F	G	H	J
AMF32	1/4"	7-5/8"	7/8"	1-1/4"	1-7/8"	3-3/4"	1"	3/8"	.20"
AMF42	1/4"	7-5/8"	1-1/8"	1-1/2"	1-7/8"	3-3/4"	1"	1/2"	.20"
AMF43	3/8"	8"	1-1/8"	1-1/2"	2"	4"	1"	1/2"	.20"

3 in 1 Manifolds

Applications:

- supplies 3 air operated tools from a single hose, permits use of air by more than one mechanic
- mount to pipe at workbench or overhead
- different tools in the shop use different styles of couplers, mount 3 different style couplers on one manifold



NPT Inlet (1)	NPT Outlet (3)	Aluminum Part #
1/4"	1/4"	D3404
3/8"	1/4"	D3406
1/2"	1/4"	D3408

2 in 1 Manifolds

Applications:

- supplies 2 air operated tools from a single hose, permits use of air by more than one mechanic
- mount to pipe at workbench or overhead
- different tools in the shop use different styles of couplers, mount 2 different style couplers on one manifold
- stock quantity only



NPT Inlet (1)	NPT Outlet (2)	Aluminum Part #
1/4"	1/4"	D2404
3/8"	1/4"	D2406
1/2"	1/4"	D2408

Flat Hex Manifolds

The flat hex manifold is designed to lay flat on the floor, safely distributing three hose lines to the work area.



NPT Inlet (1)	NPT Outlet (3)	Brass Part #
1/4"	1/4"	3122
3/8"	1/4"	3132
3/8"	3/8"	3133

In-Line Swivels

- heavy-duty, free turning steel swivel
- *for air service only*
- rated to **250 PSI** at ambient temperature (70°F), minimum **35 PSI**

Male NPT	Female NPT	Steel Part #
3/8"	1/2"	SV17
1/2"	1/2"	SV20
3/4"	3/4"	SV26

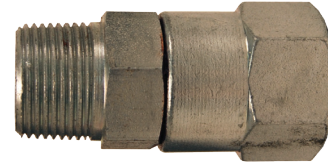

- *for air service only*
- rated to **150 PSI** at ambient temperature (70°F)

Male NPT	Female NPT	Brass Part #
1/4"	1/4"	D344R
3/8"	3/8"	D366R

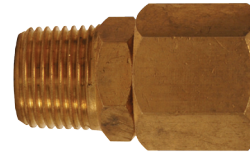

Air Tool Swivels

- swivels at two locations so air hose can drop directly to the floor
- rated to **150 PSI** at ambient temperature (70°F)

Size	Aluminum Part #
1/4"	D344U¹
3/8"	D346U
1/2"	D348U

¹ D344U is a non-marring composite.



Safety Vented Ball Valves

- for air service only
- rated to **600 PSI**
- Lockable ball valves vent downstream air in accordance with OSHA regulation 1910.147 for pneumatic systems.
- 1/4" - 1/2" full port; 3/4" - 2" standard port
- brass valve
- chromium plated ball
- RTFE seats and stuffing box ring
- blow-out proof stem design
- adjustable packing gland

female NPT x female NPT

Size	Port Type	Brass Part #
1/4"	full	BBV25LV
3/8"	full	BBV38LV
1/2"	full	BBV50LV
3/4"	standard	BBV75LV
1"	standard	BBV100LV
1-1/4"	standard	BBV125LV
1-1/2"	standard	BBV150LV
2"	standard	BBV200LV

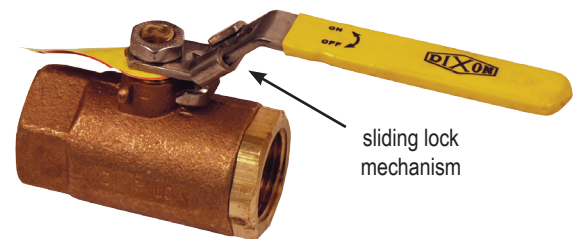

Brass Flow Control Valves

Series F

- Exclusive color coded reference scale on the adjusting knob greatly simplifies flow setting, resetting, adjusting and return to an original flow.
- A simple set screw locks the valve on any desired setting.
- maximum operating pressure: **2000 PSI** at ambient temperature (70°F) for sizes 1/8" - 3/4", **500 PSI** at ambient temperature (70°F) for 1"
- also available in steel, see page 360



Thread	Brass Part #
1/8"	BFC200
1/4"	BFC400
3/8"	BFC600
1/2"	BFC800
3/4"	BFC1200
1"	BFC1600

Series PF

- Utilizes a ball type check that meters flow of air in one direction and allows free flow in the reverse direction.
- Used to control actuator speed by acting as a restriction.
- maximum operating pressure: **2000 PSI** at ambient temperature (70°F)
- cracking pressure: **5 PSI**
- also available in steel, see page 360



Thread	Brass Part #
1/8"	BPF200
1/4"	BPF400
3/8"	BPF600
1/2"	BPF800

Series N

- maximum operating pressure: **2000 PSI** at ambient temperature (70°F) for sizes 1/8" - 3/4", **500 PSI** at ambient temperature (70°F) for 1"
- also available in steel, see page 360



Thread	Brass Part #
1/8"	BN200
1/4"	BN400
3/8"	BN600
1/2"	BN800
3/4"	BN1200
1"	BN1600

Brass Check Valves - Series C

- provides free flow in one direction and dependable shutoff in the opposite direction
- maximum operating pressure: **2000 PSI** at ambient temperature (70°F)
- cracking pressure: **5 PSI**
- also available in steel, see page 360



Female NPT	Free Flow GPM	Brass Part #
1/8"	3	BCV200
1/4"	5	BCV400
3/8"	8	BCV600
1/2"	15	BCV800

Dixon is recognized as the premier manufacturer and supplier of hose fittings and accessories spanning a wide range of industrial uses. Dixon's range includes products for food, dairy processing, beverage and brewery, mobile tankers, mining, construction, chemical processing, petroleum, oilfields, refining and manufacturing.

dixonvalve.com • Customer Service: 877.963.4966

Dixon Valve

800 High Street, Chestertown, MD 21620

Fax: 800.283.4966



YouTube™



Dixon
Customer Service